

# ENCARGO 20 - CELEBRACIÓN

- 10 invitados + 1 anfitrión

Posibilidades de recibida:

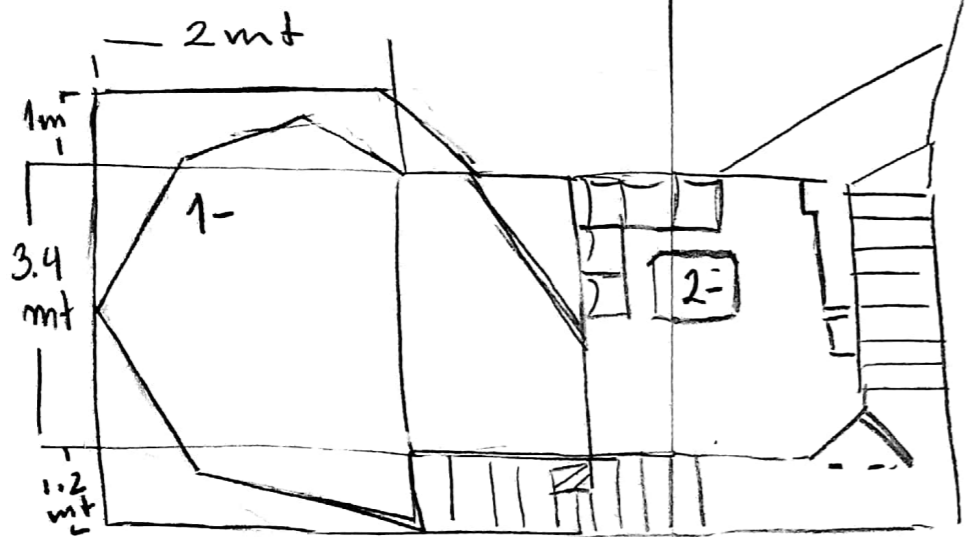

1- Patio: - Más espacio  
- Vista a la costa ✓

2- Comedor: - cercanía a la cocina  
- built-in asientos X

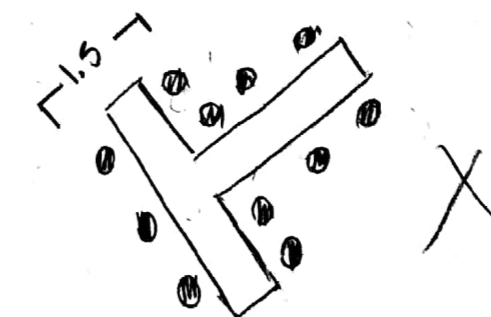
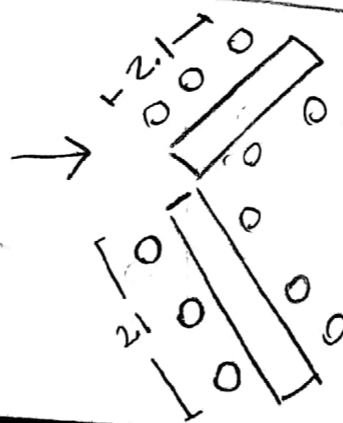
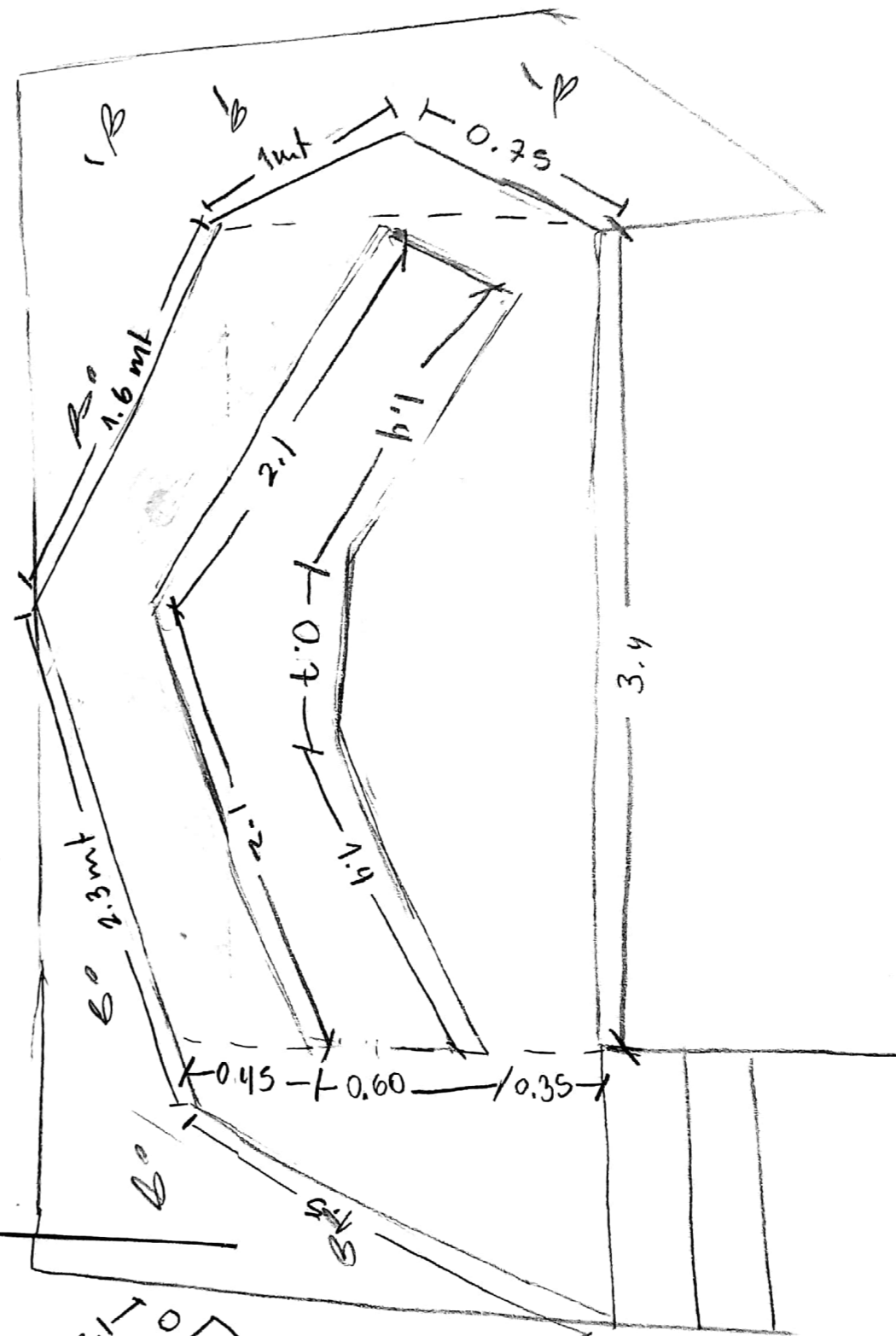
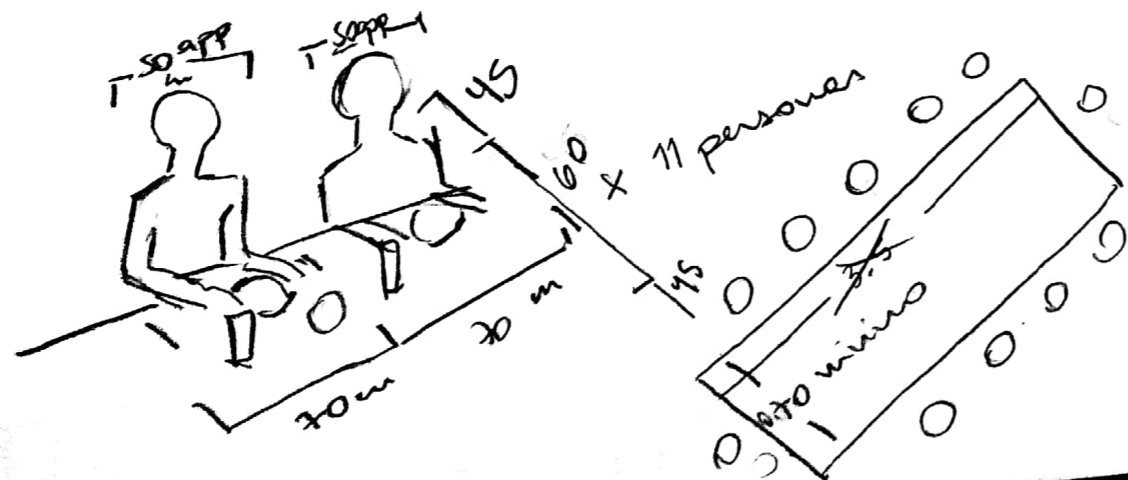

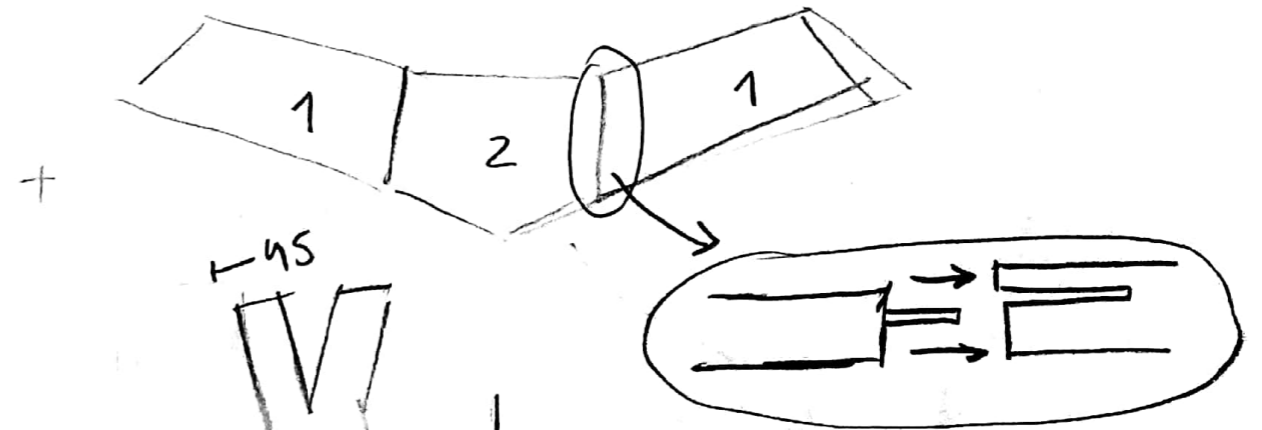
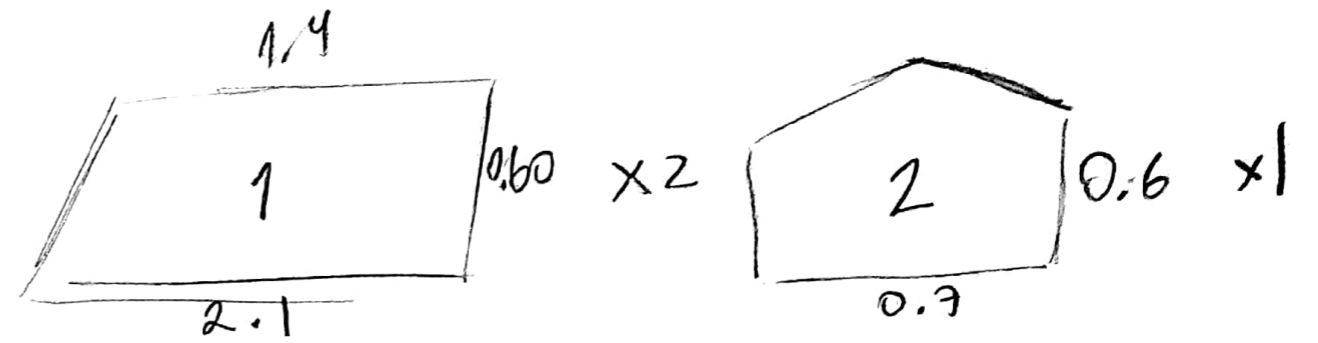
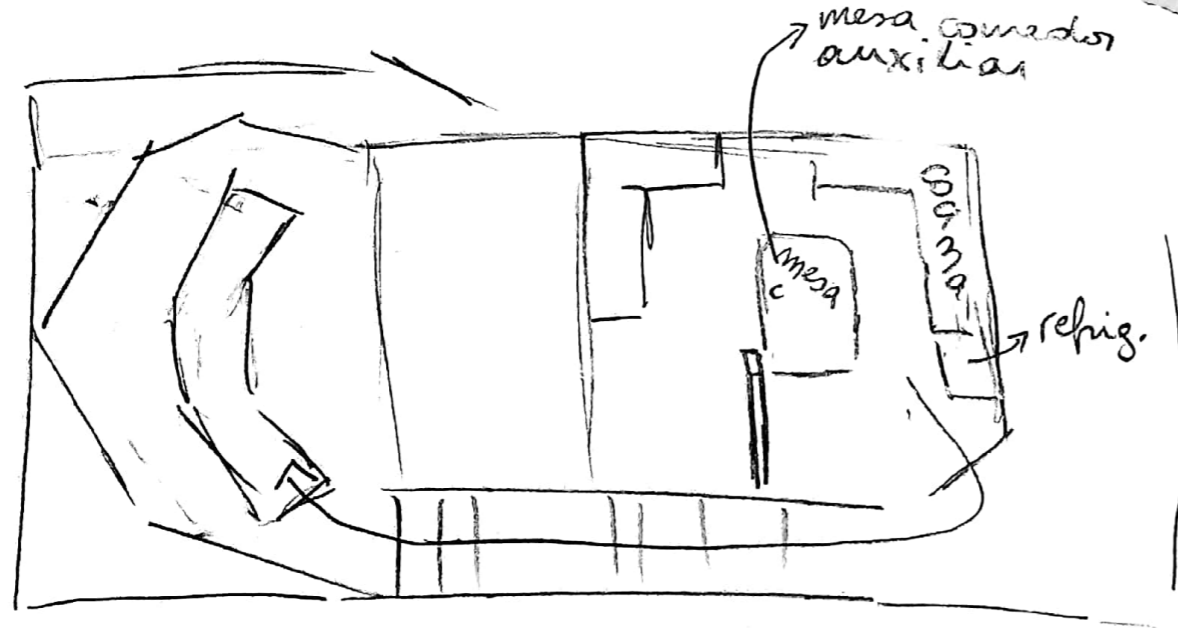

soporter

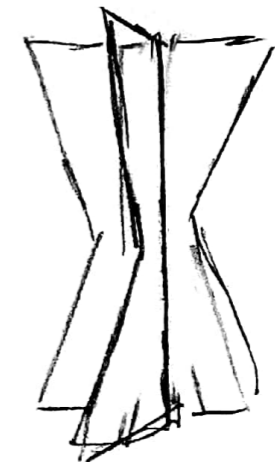
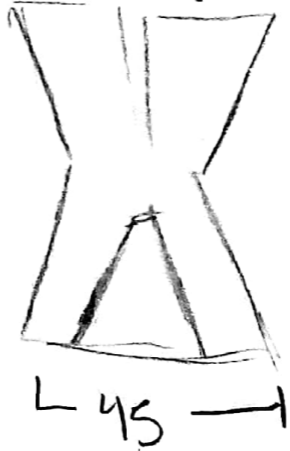

x3

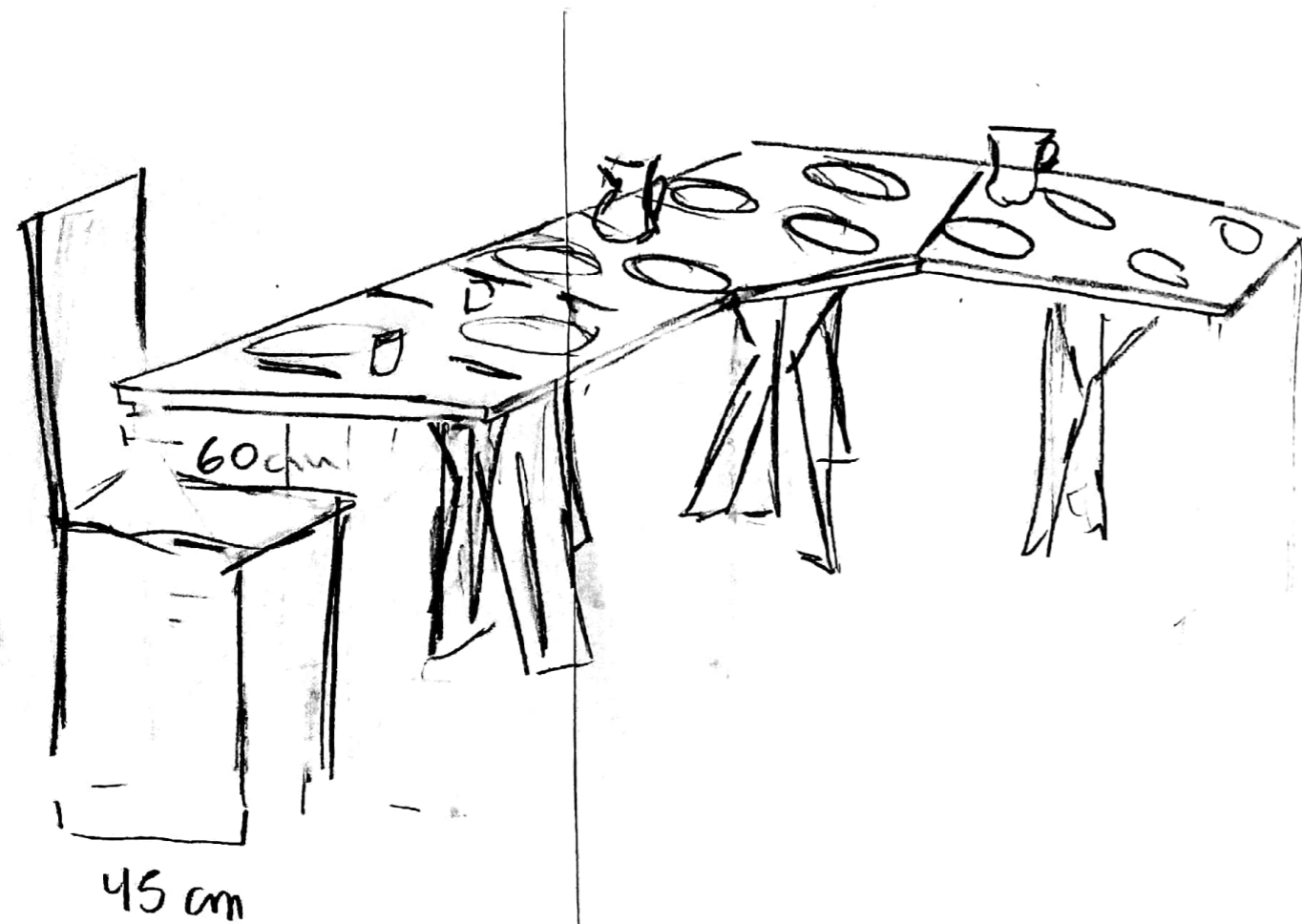

Mesa  
desmontable  
para celebración  
en el cubículo

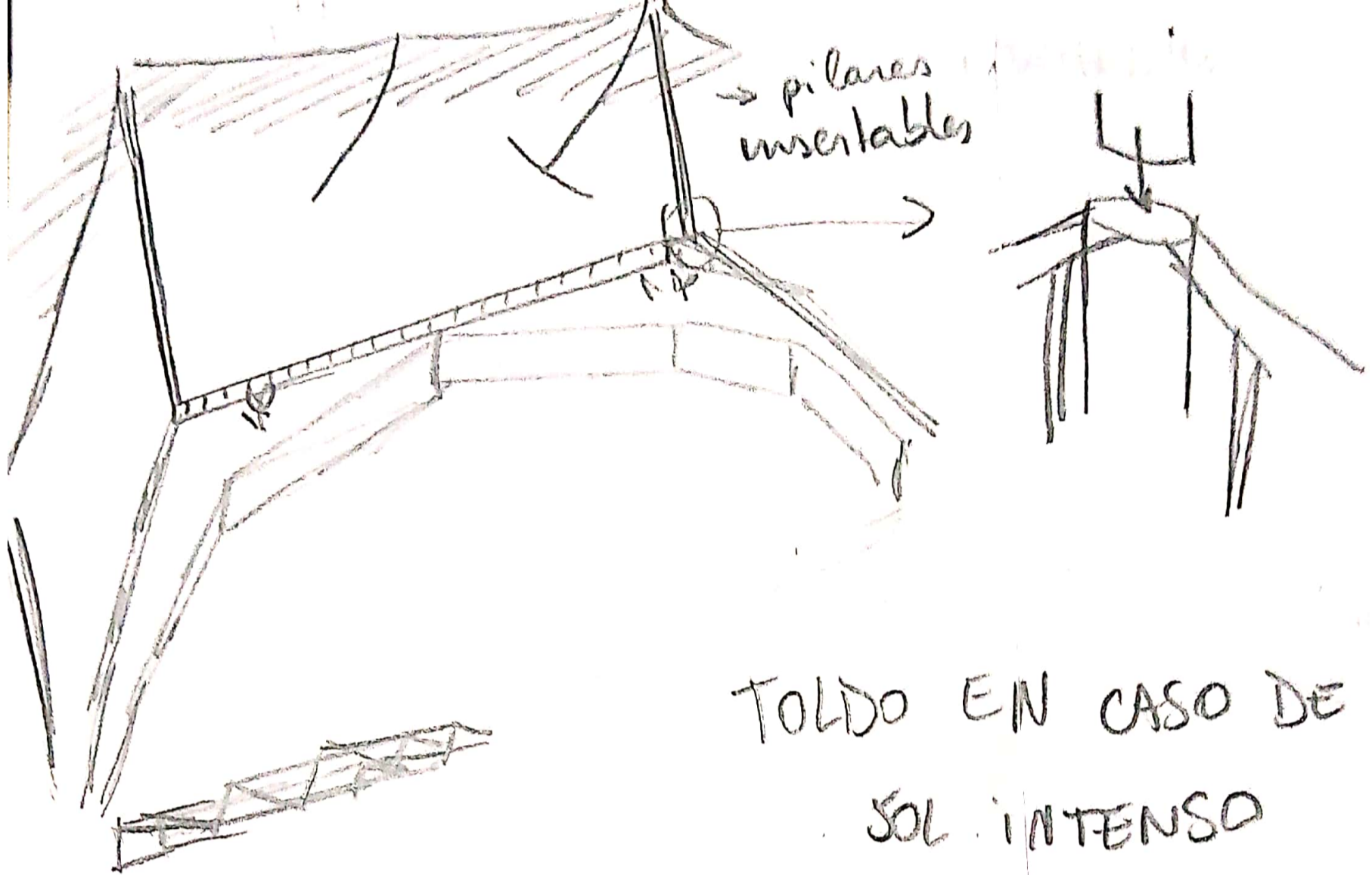

TOLDO EN CASO DE SOL INTENSO

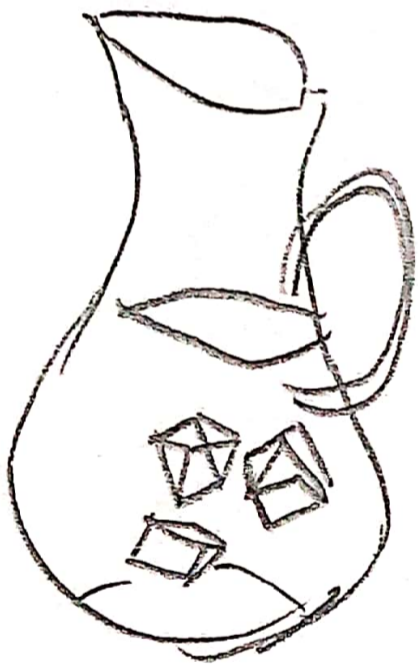

jarras 2 litros

+

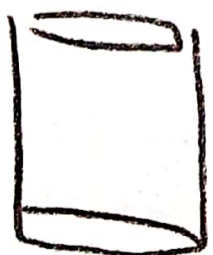

vasos pequeños

limonada / jugo

(pensando 1/2 litro x persona se redondea a 6-7 litros)

