

PLANIMETRÍA

Taller acceder a la observación

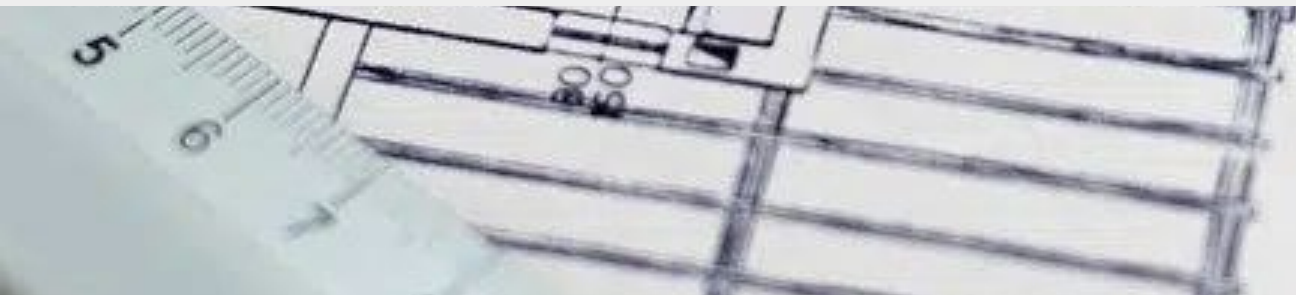



CONFECCIÓN DE UN PLANO

- Papel blanco
- Escalímetro o regla
- Porta minas o tiralíneas

PLANOS ARQUITECTÓNICOS

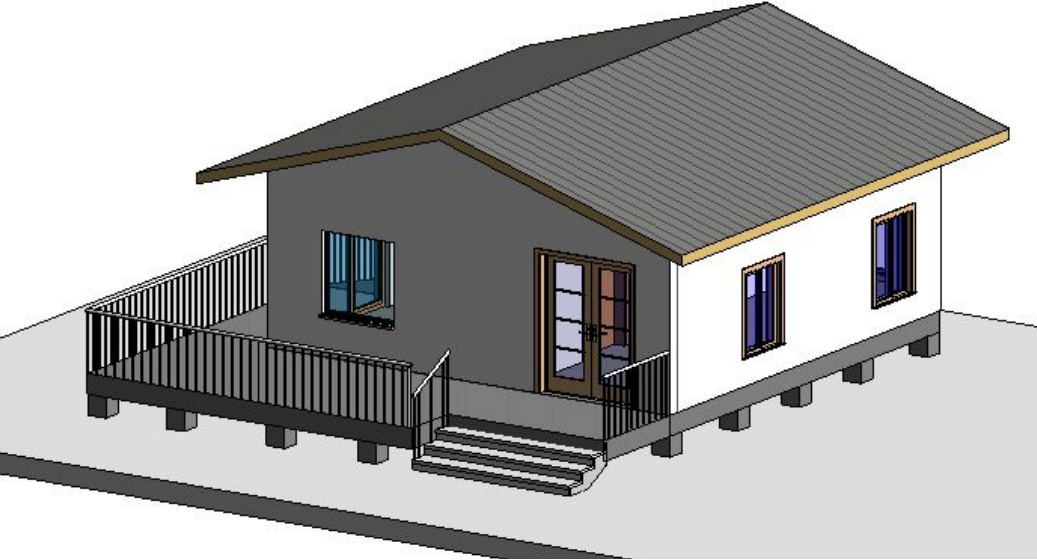

- Ubicación
- Emplazamiento
- Plantas
- Elevaciones
- Cortes
- Detalles y escantillones

PLANOS ARQUITECTÓNICOS

- **Ubicación**
- Emplazamiento
- Elevaciones
- Plantas
- Cortes

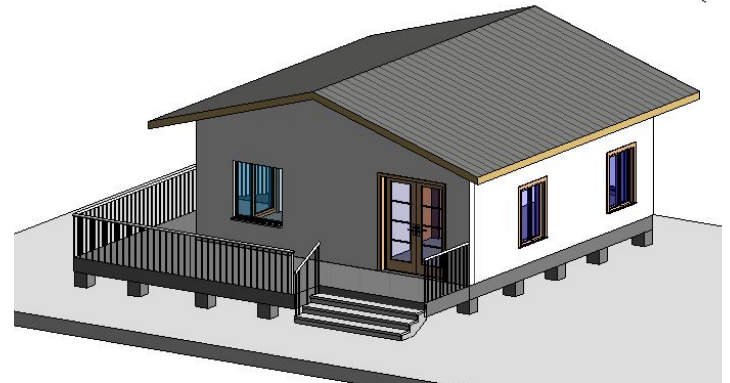
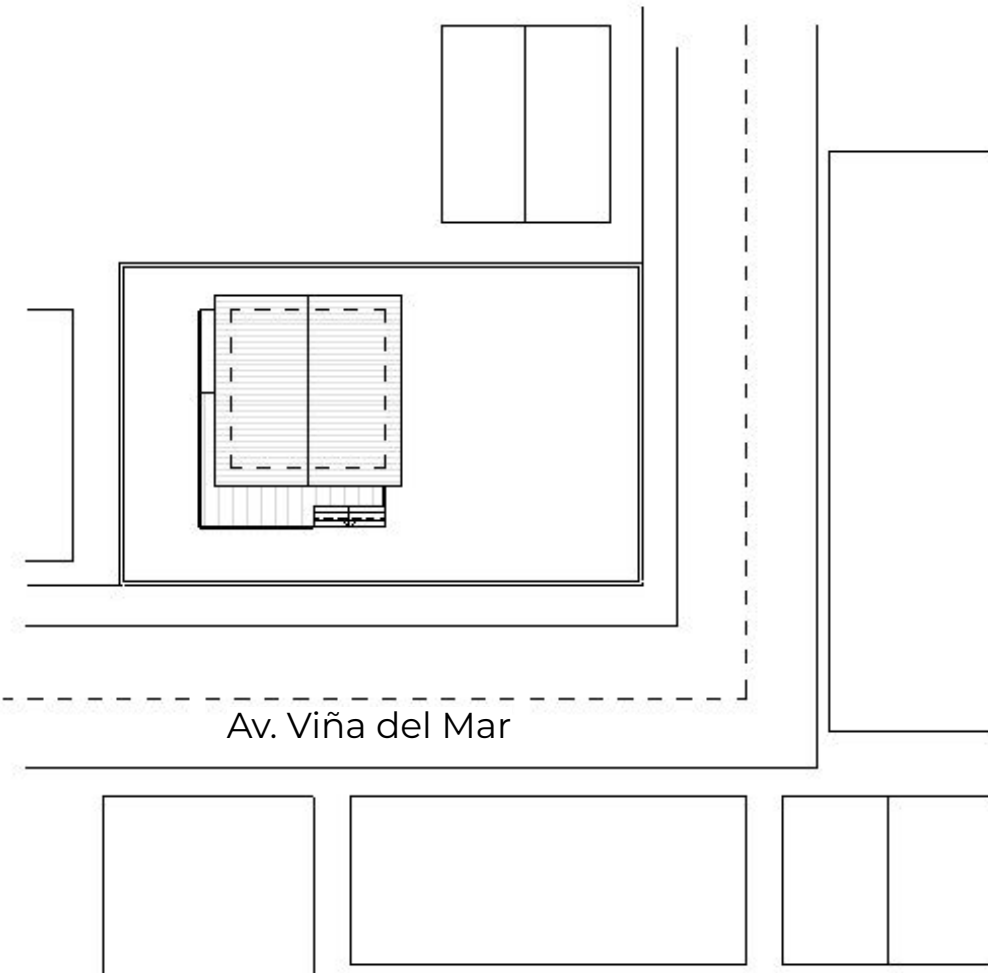

PLANOS ARQUITECTÓNICOS

- Ubicación
- **Emplazamiento**
- Elevaciones
- Plantas
- Cortes

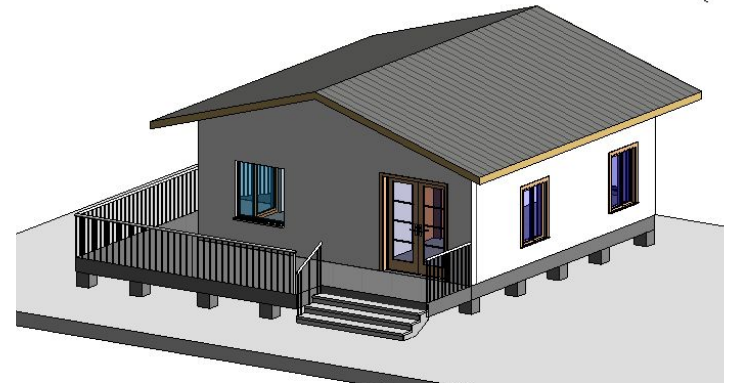
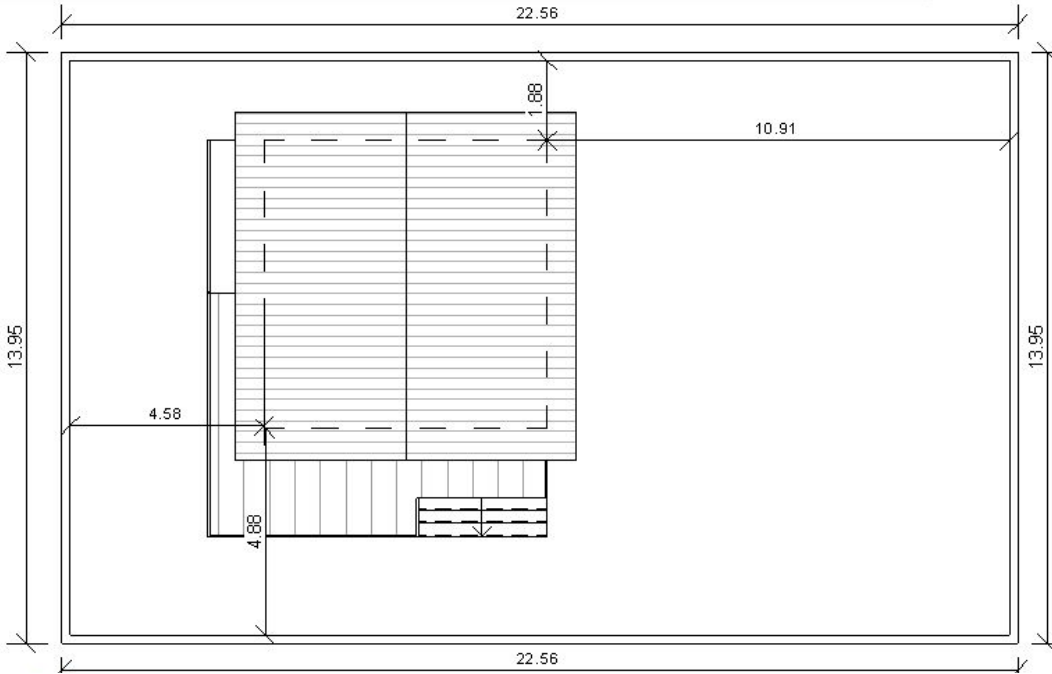

PLANOS ARQUITECTÓNICOS

- Ubicación
- Emplazamiento
- **Elevaciones**
- Plantas
- Cortes

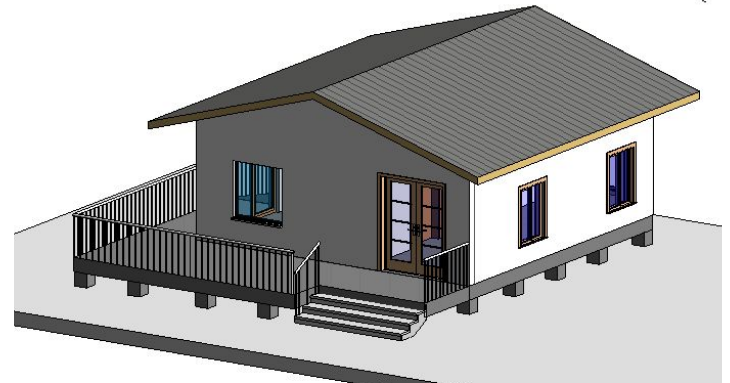
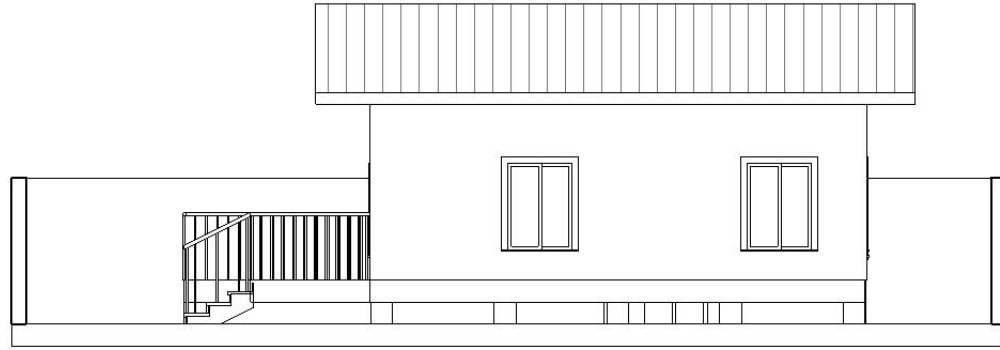

PLANOS ARQUITECTÓNICOS

- Ubicación
- Emplazamiento
- **Elevaciones**
- Plantas
- Cortes

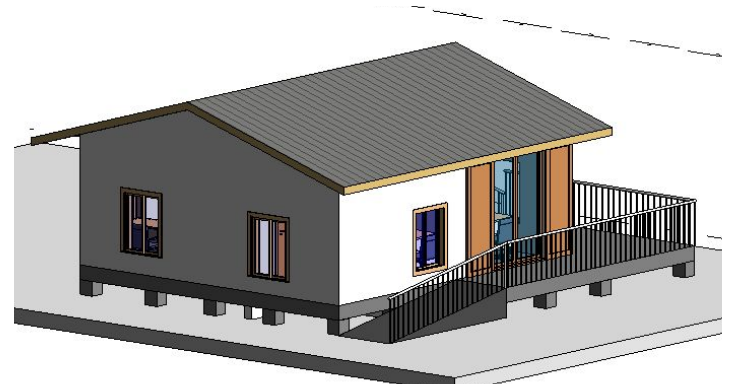
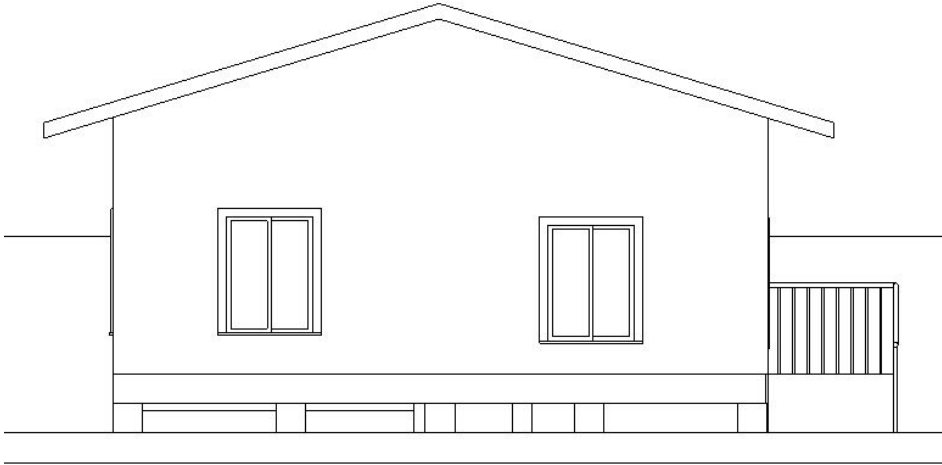



PLANTAS

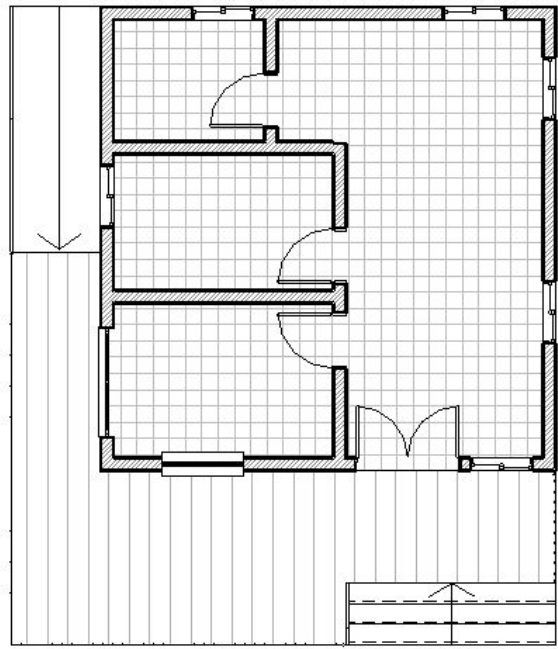
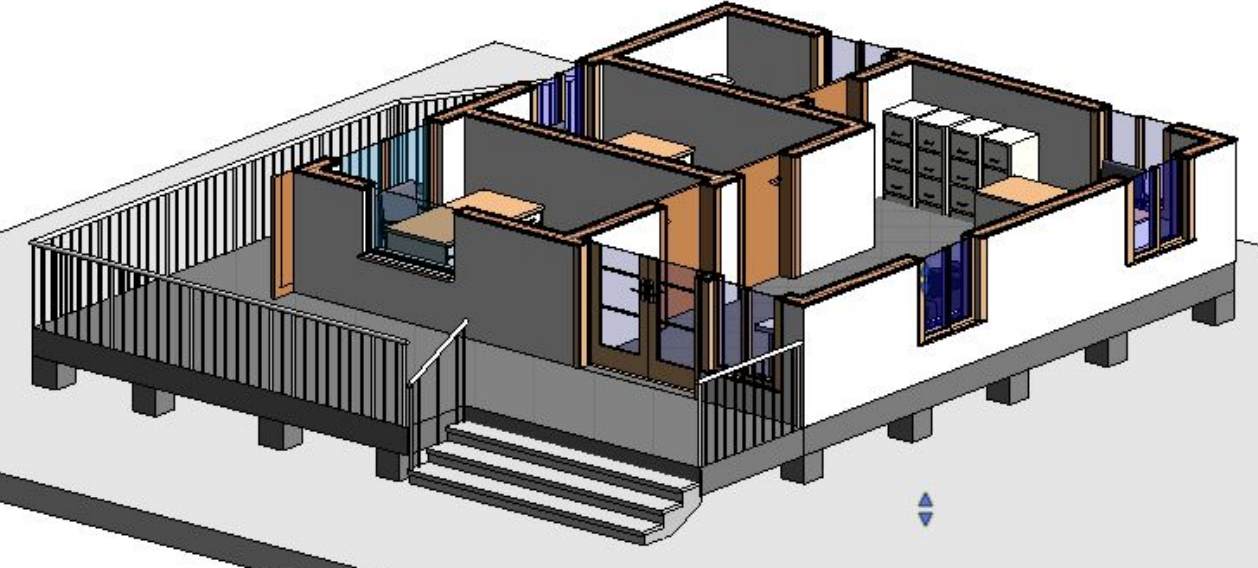

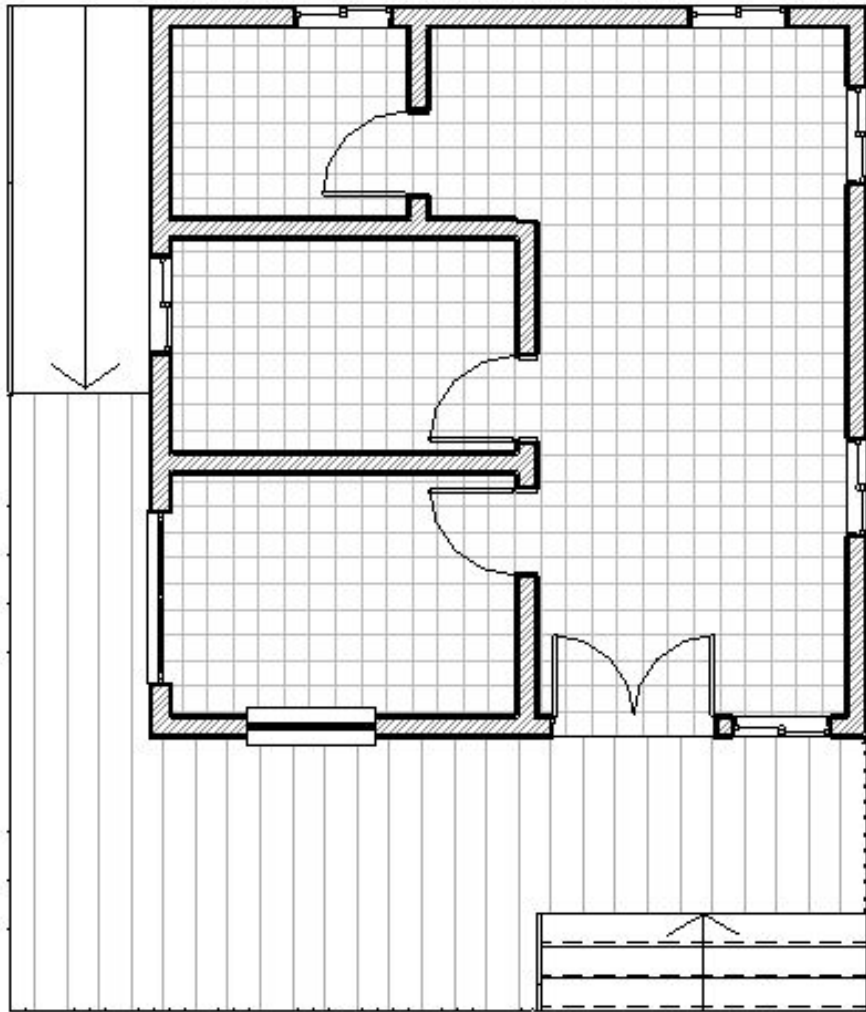

PLANTAS

- **Muros**
- **Ventanas y Puertas**
- **Suelos**
- Mobiliario
- Escaleras
- Rampas



PLANTAS

- Muros
- Ventanas y Puertas
- Suelos
- **Mobiliario**
- **Escaleras**
- **Rampas**

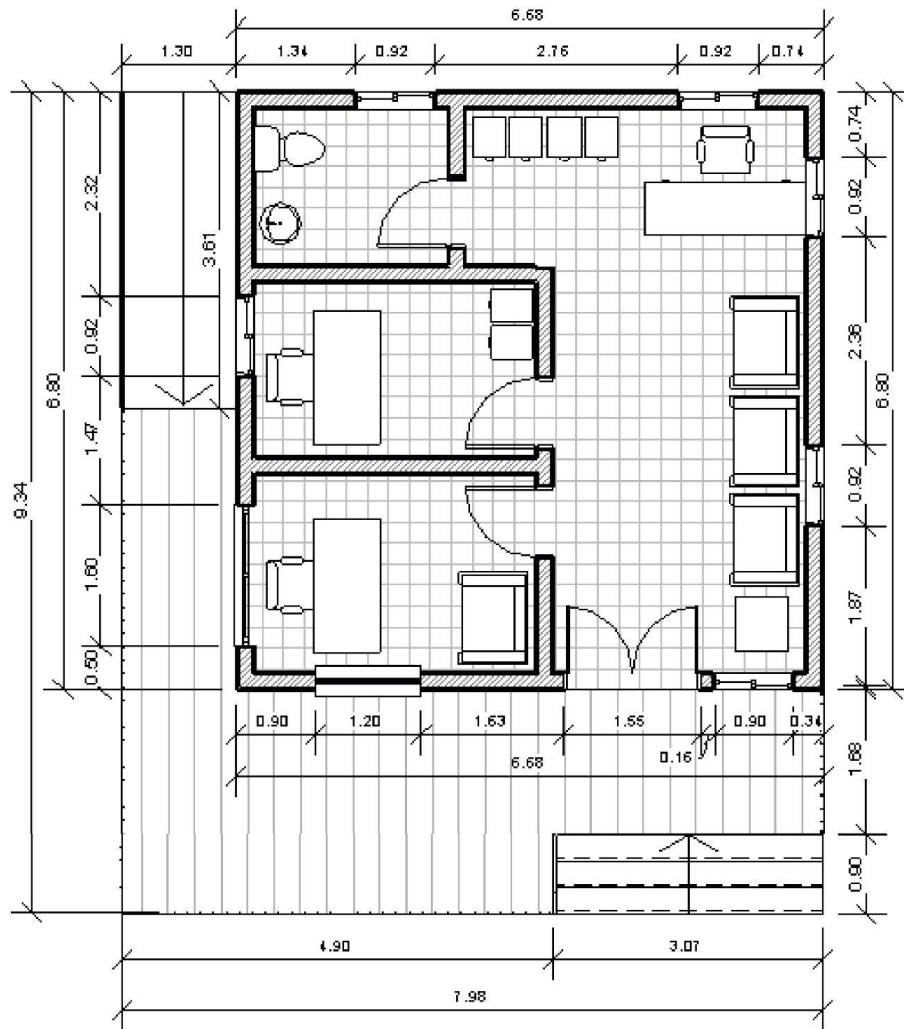

PLANTAS

- **Cotas (Exteriores)**
- Niveles
- Nombre recintos
- M2
- Cortes

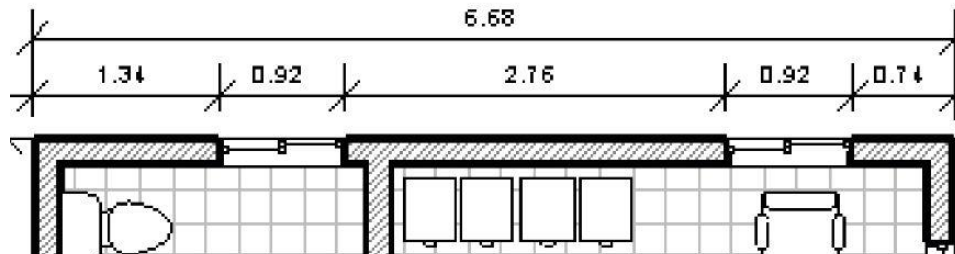

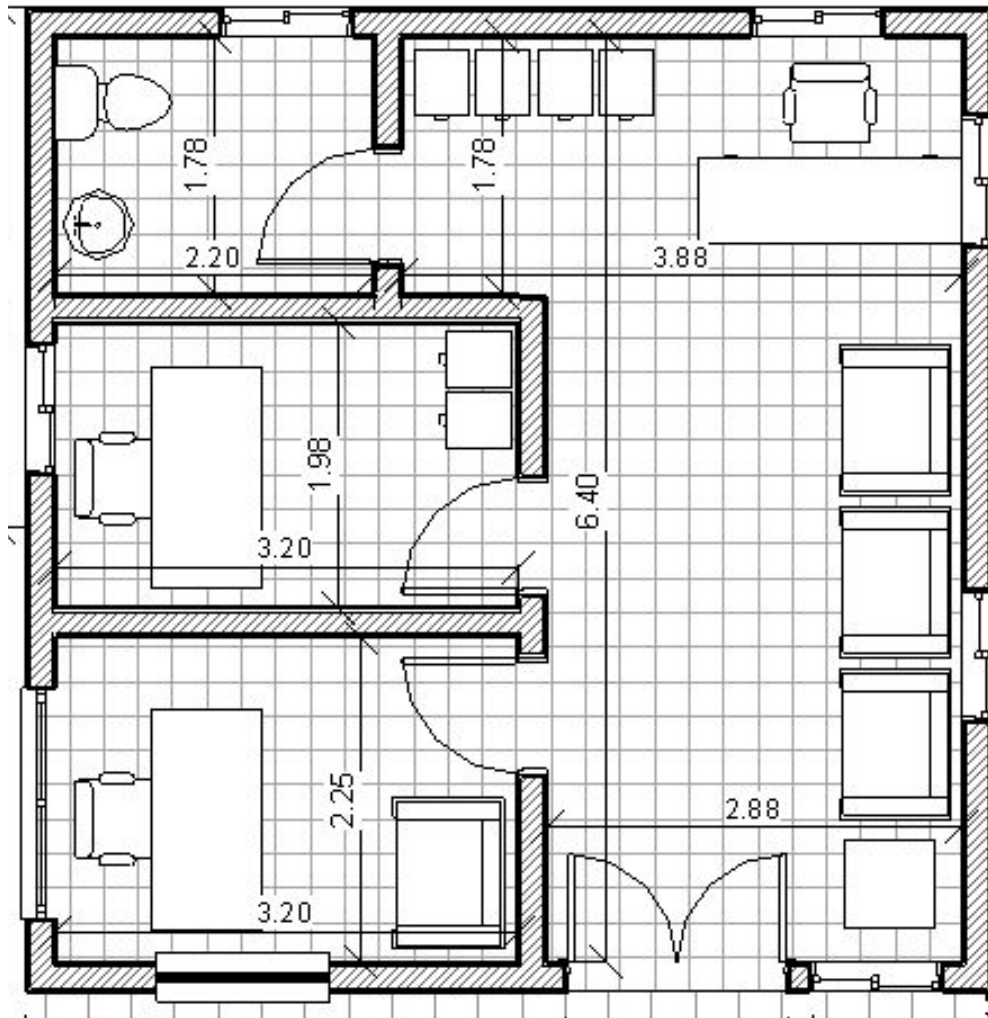

PLANTAS

- **Cotas (Interiores)**
- Niveles
- Nombre recintos
- M2
- Cortes

PLANTAS

- Cotas
- **Niveles**
- Nombre recintos
- M2
- Cortes

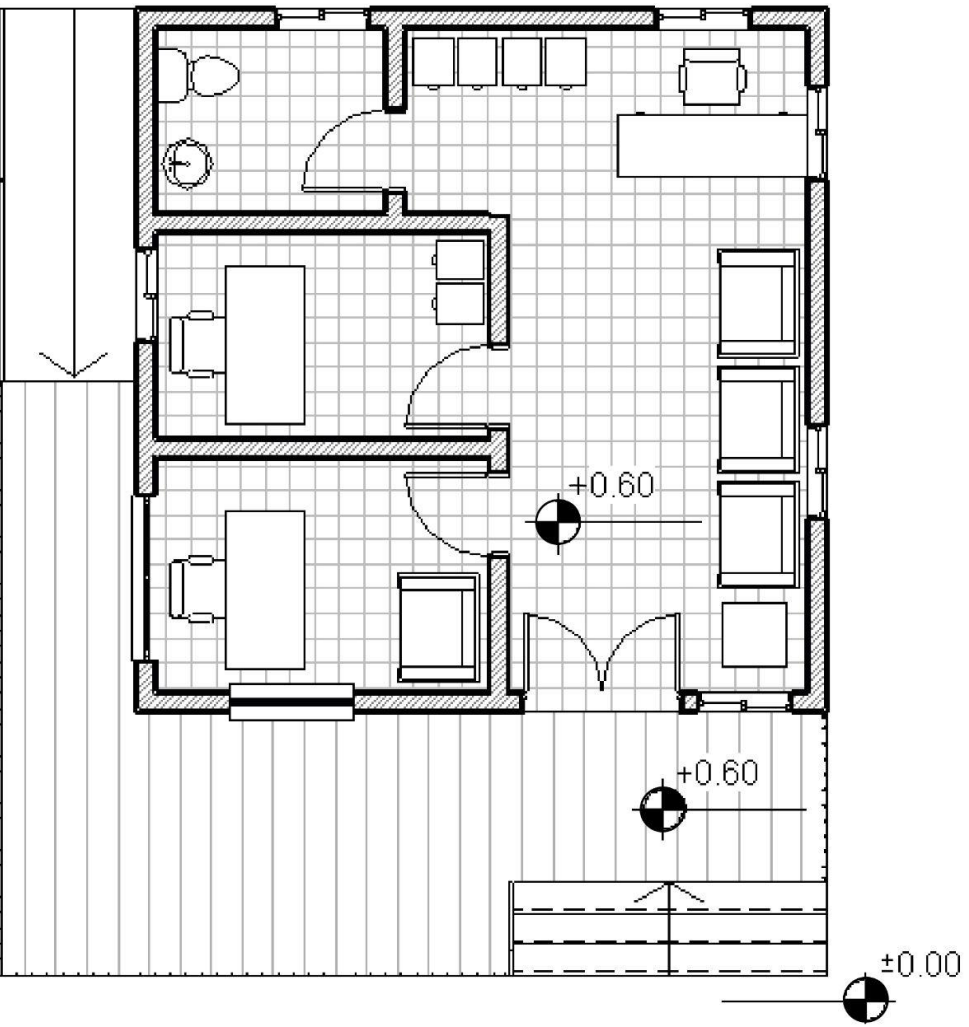

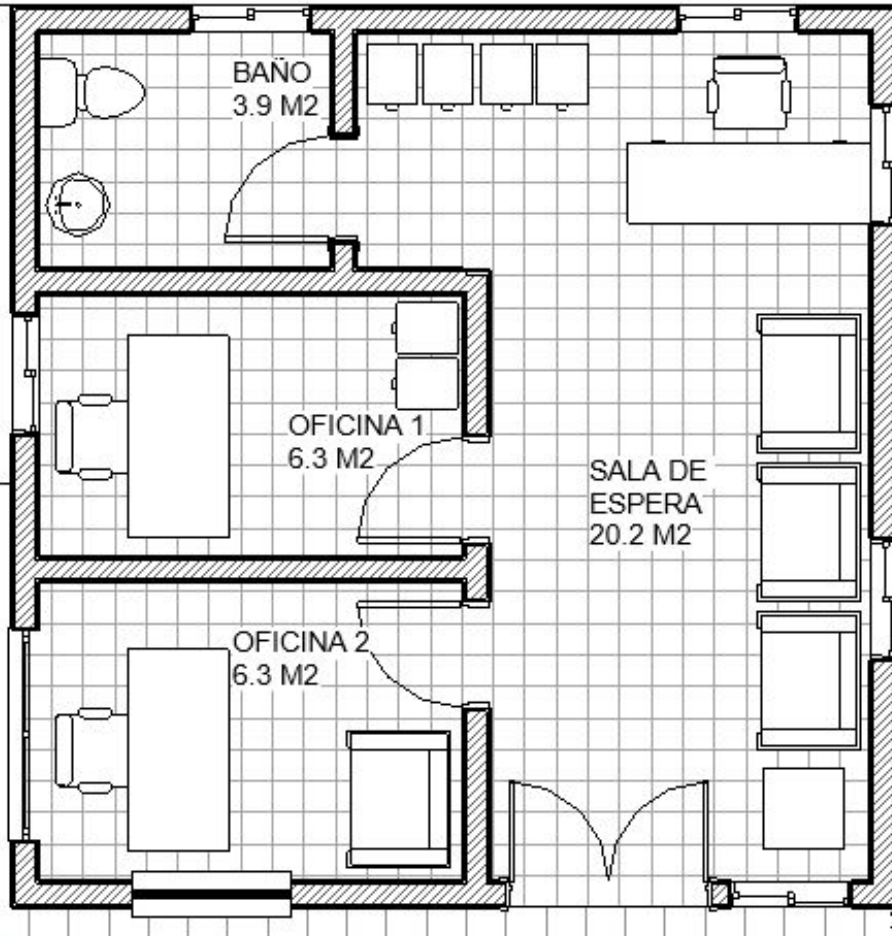

PLANTAS

- Cotas
- Niveles
- **Nombre recintos**
- **M²**
- Cortes

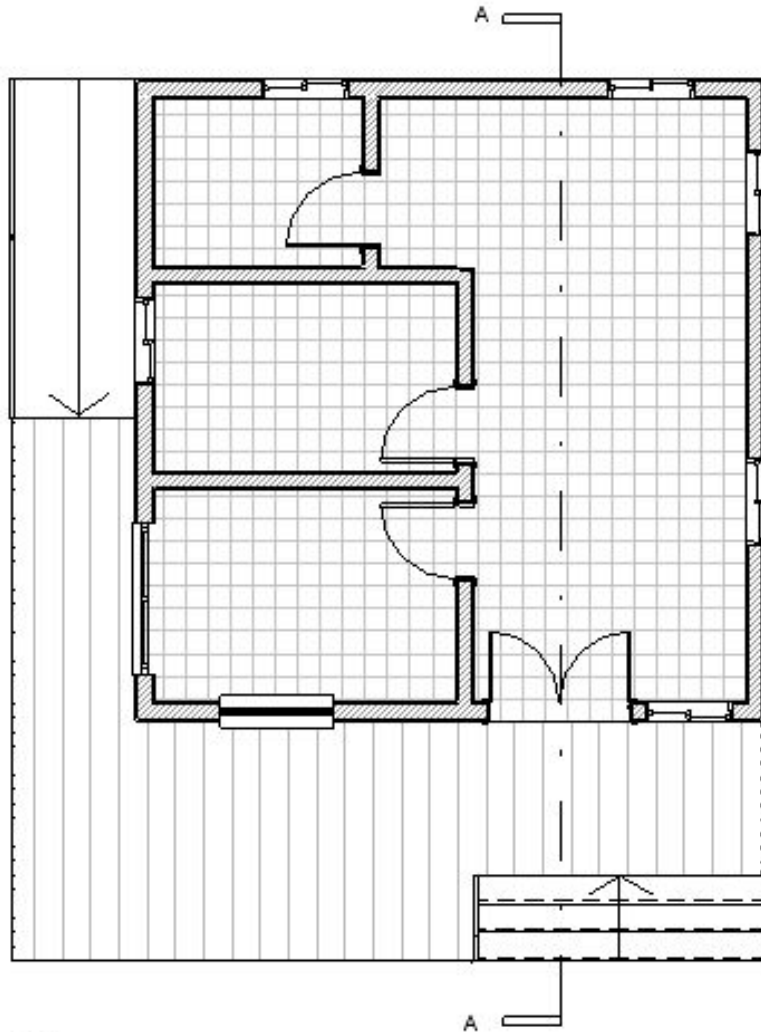

PLANTAS

- Cotas
- Niveles
- Nombre recintos
- M2
- **Cortes**

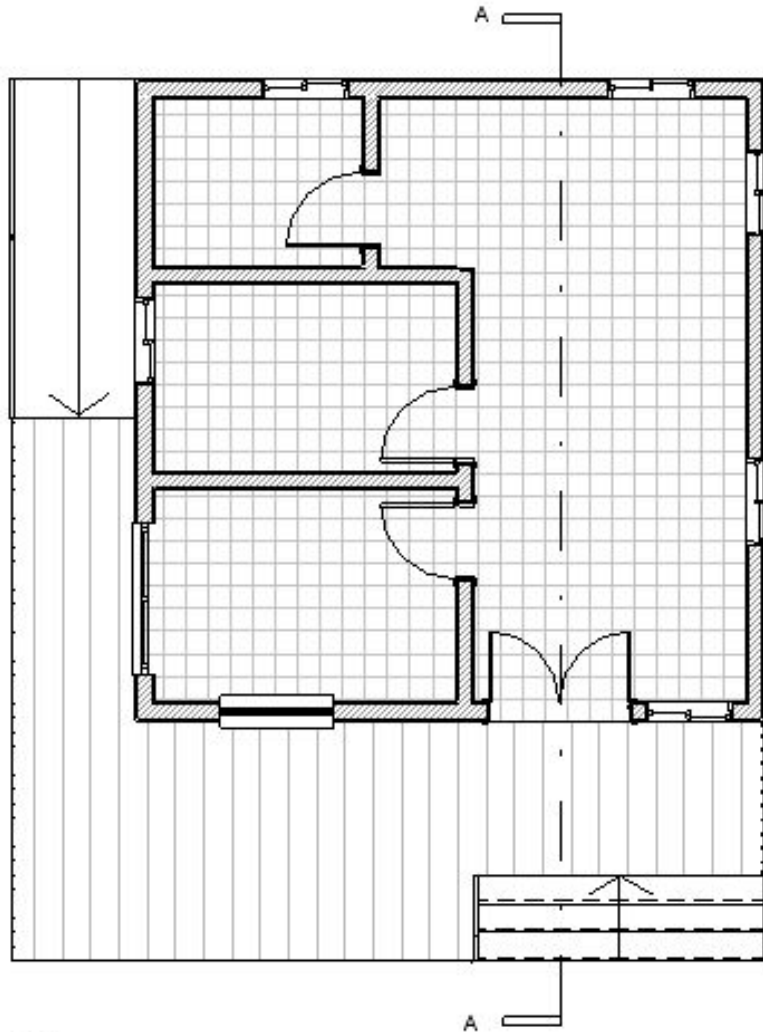

CORTE A

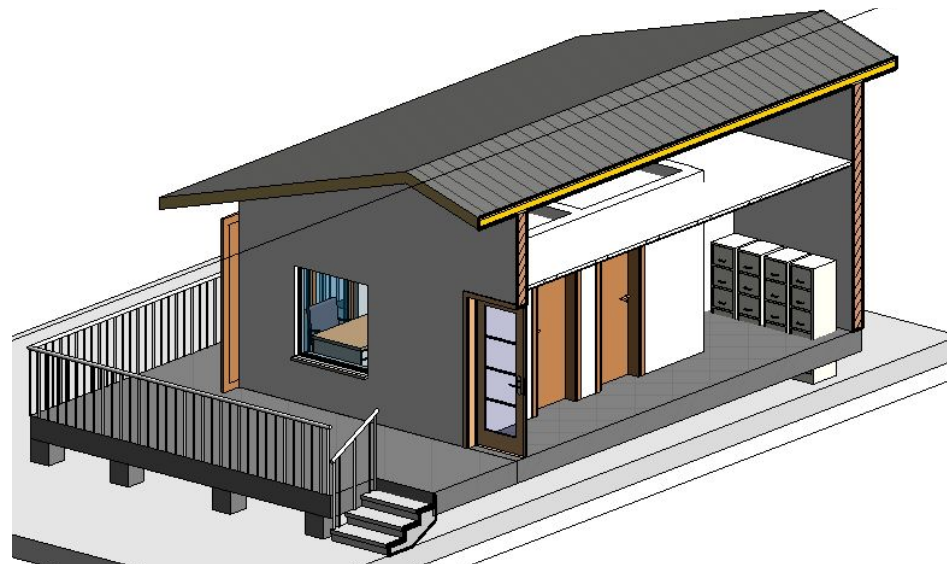

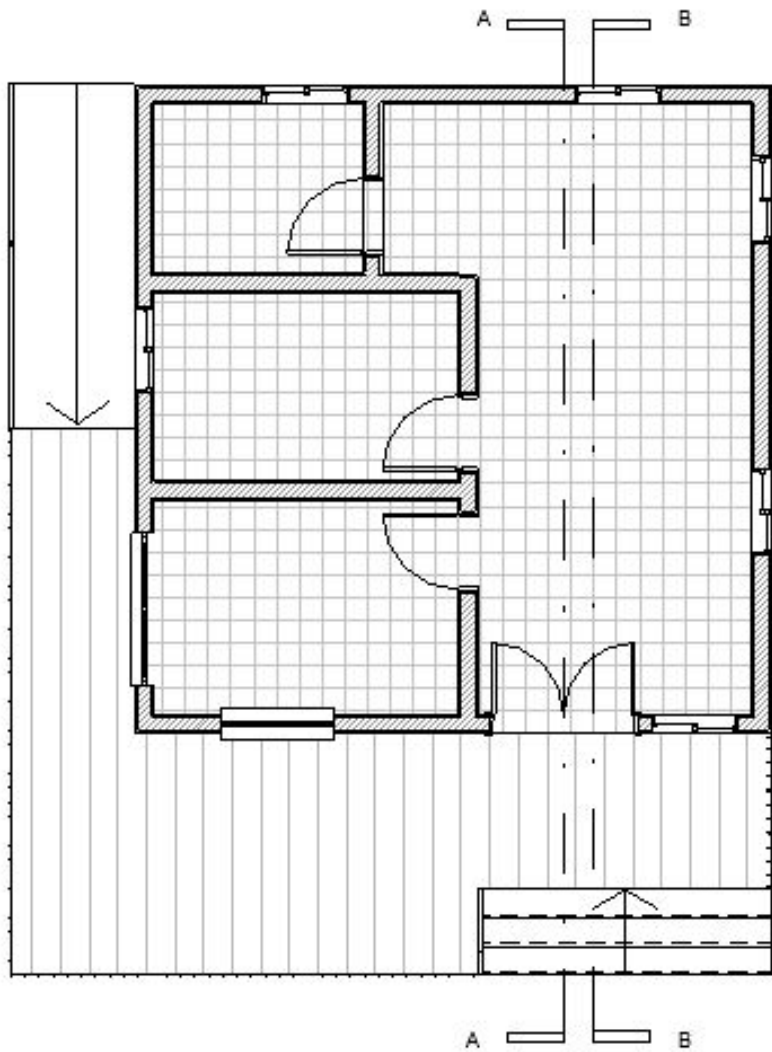

CORTE A

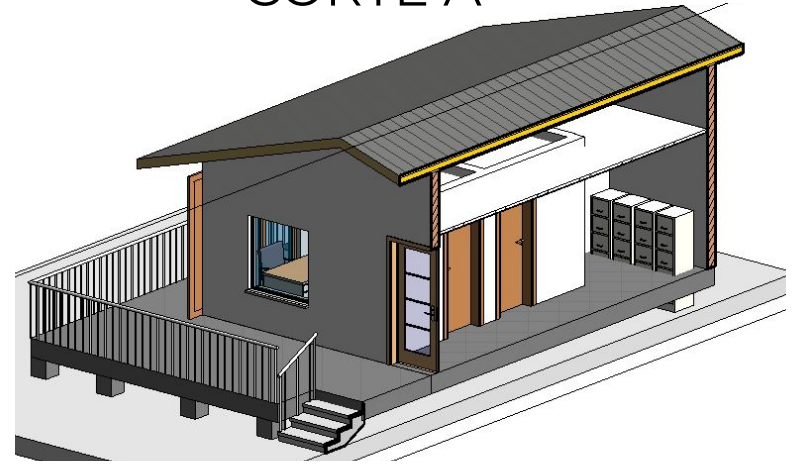

CORTE B

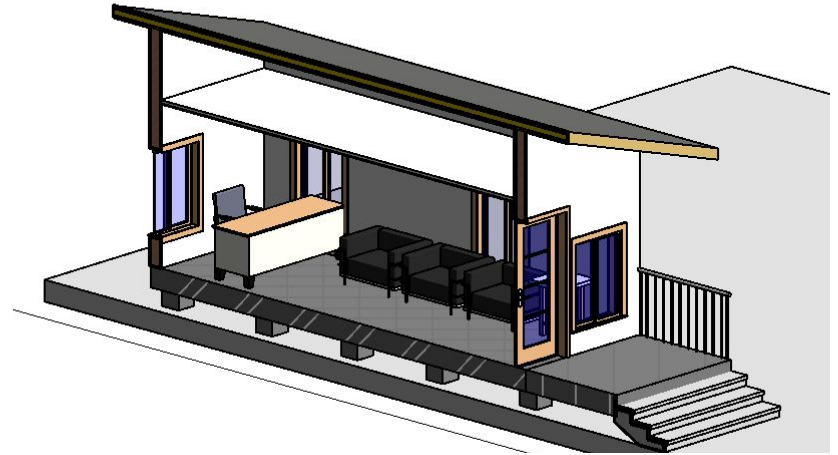

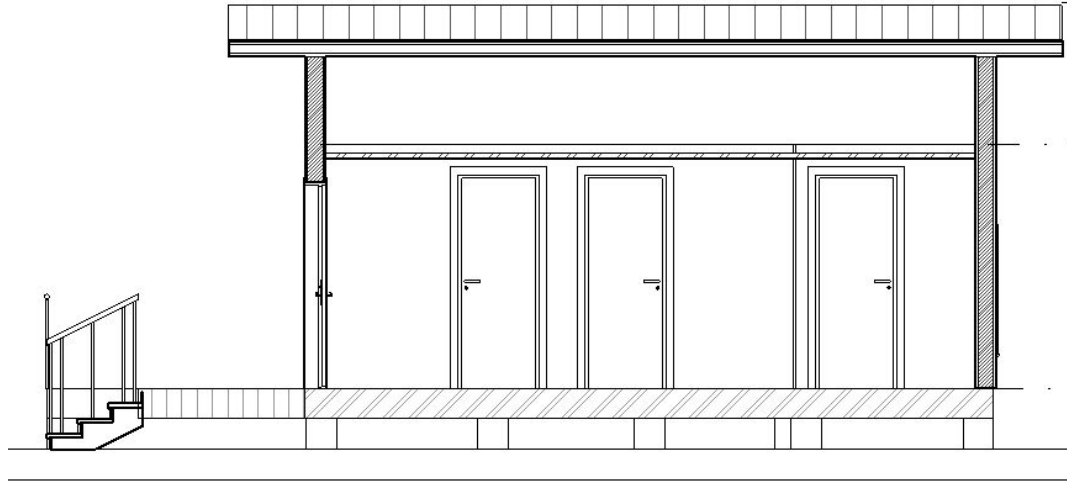

CORTE A

- **Muros**
- **Cielos**
- **Cubiertas**
- **Suelos**
- Escaleras
- Puertas
- Ventanas
- Mobiliario

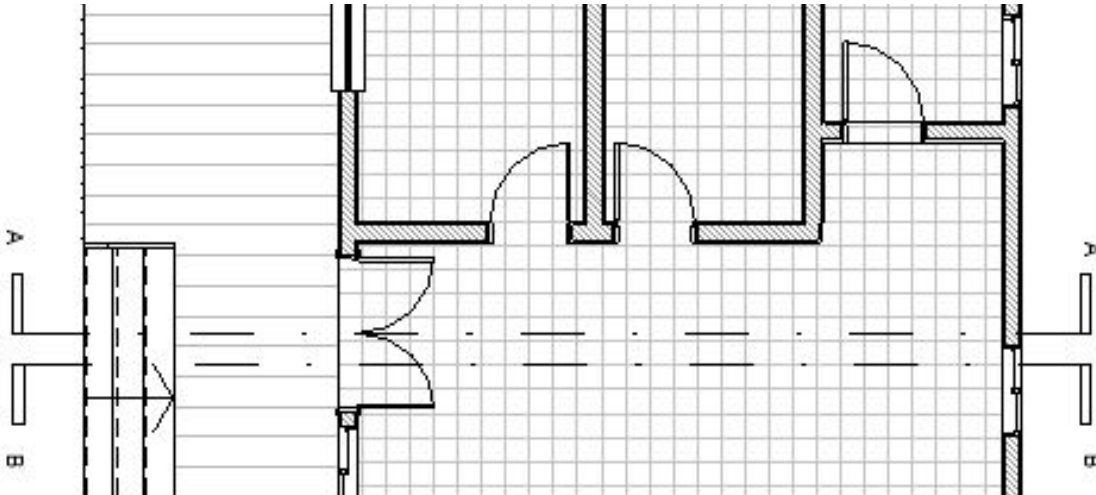

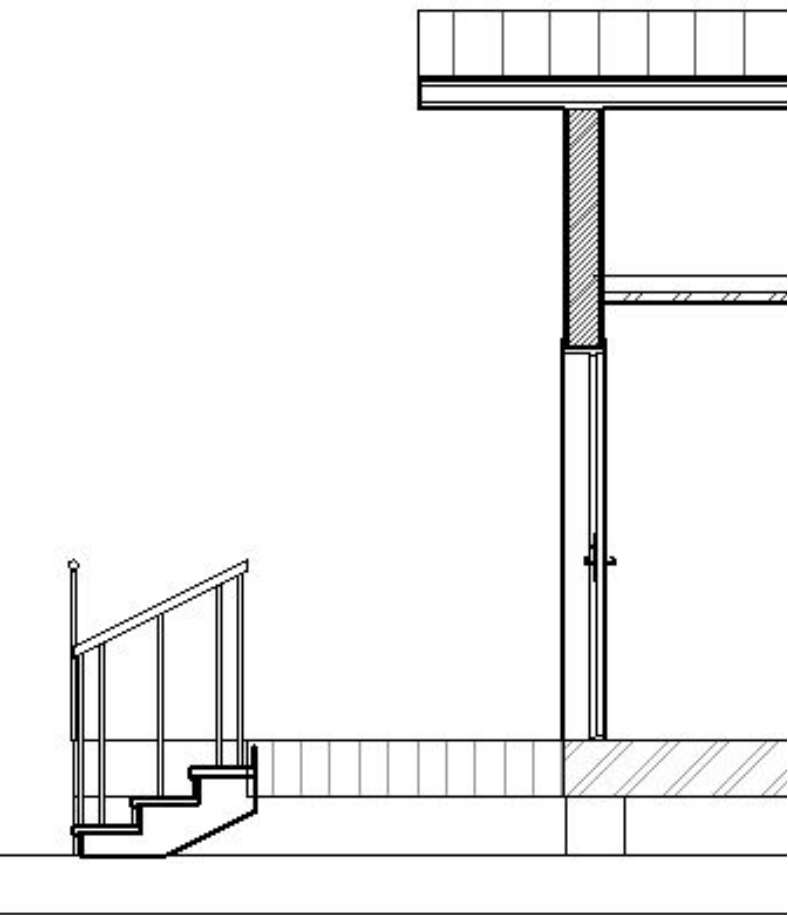

CORTE A

- Muros
- Cielos
- Cubiertas
- Suelos
- **Escaleras**
- **Puertas**
- Ventanas
- Mobiliario

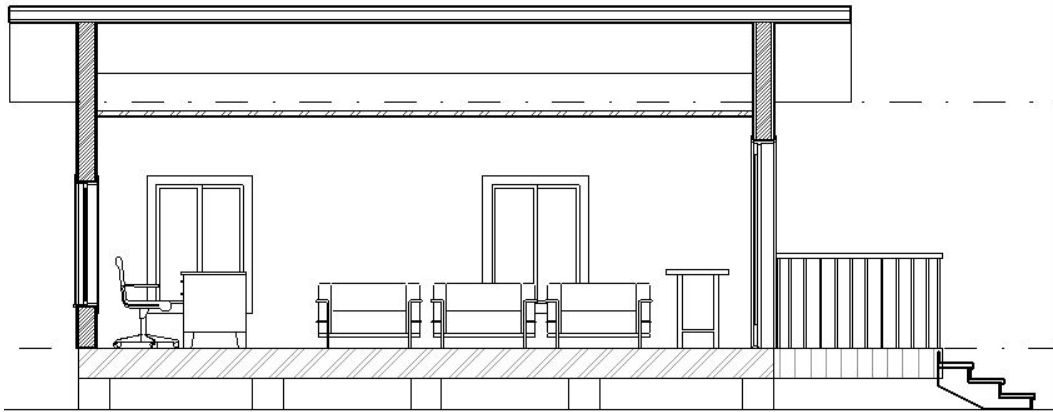

CORTE B

- Muros
- Cielos
- Cubiertas
- Suelos
- Escaleras
- Puertas
- **Ventanas**
- **Mobiliario**

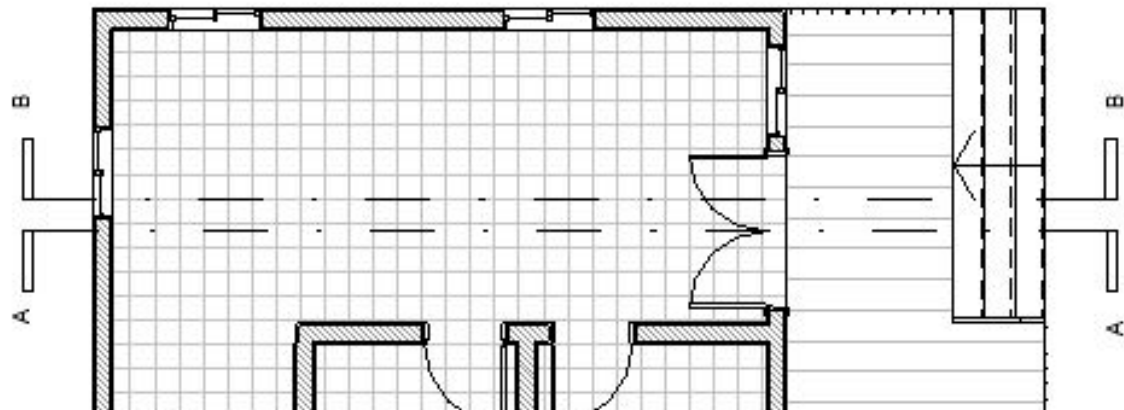

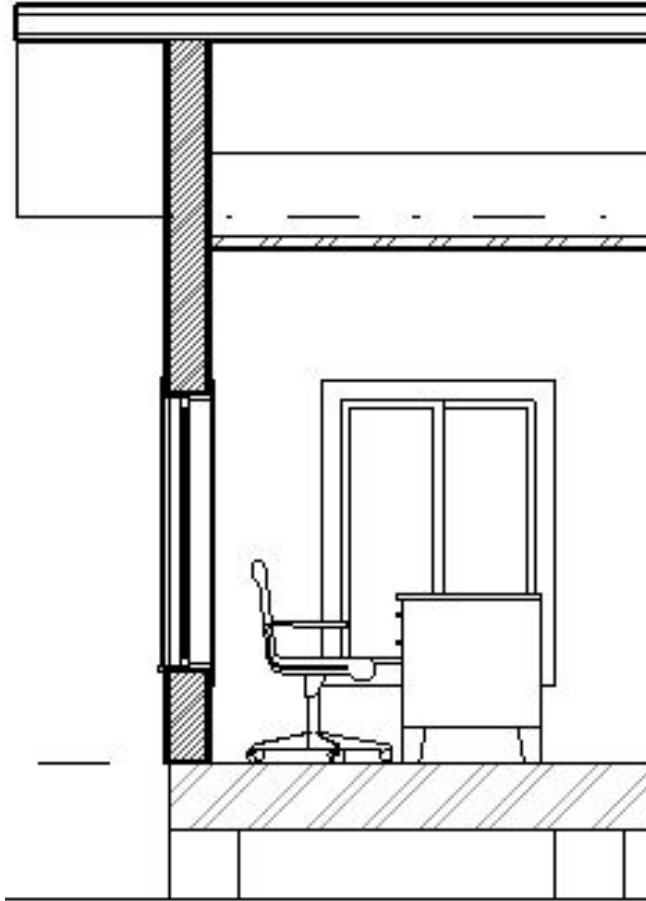

CORTE B

- Muros
- Cielos
- Cubiertas
- Suelos
- Escaleras
- Puertas
- **Ventanas**
- **Mobiliario**

CORTES

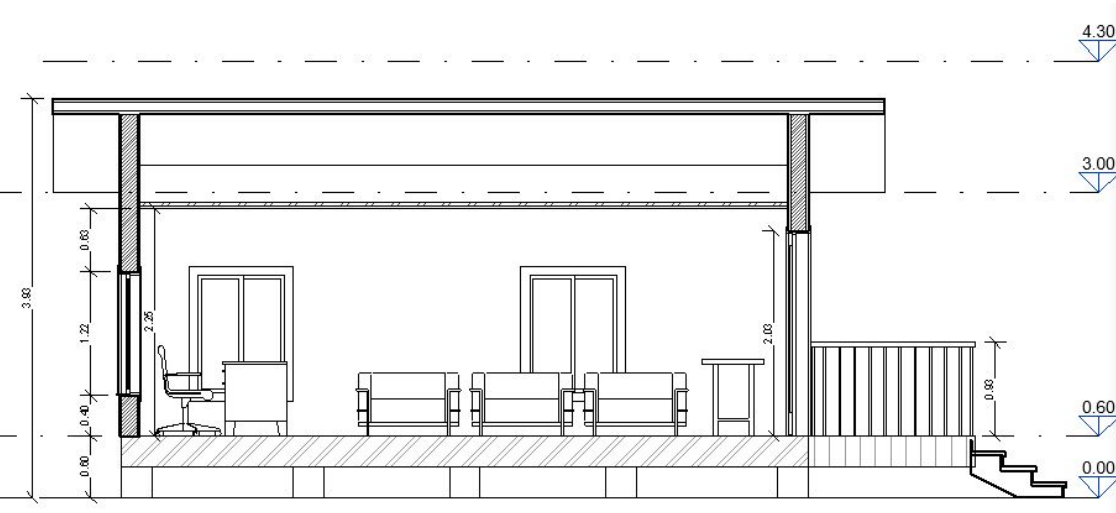

- **Niveles**
- **Cotas**
- Nombres recintos
- M2

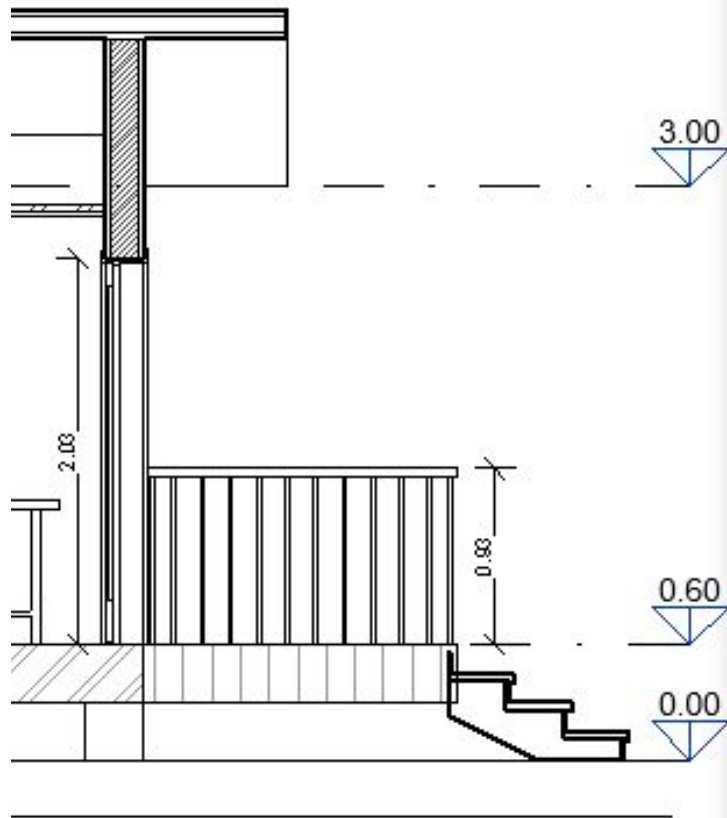
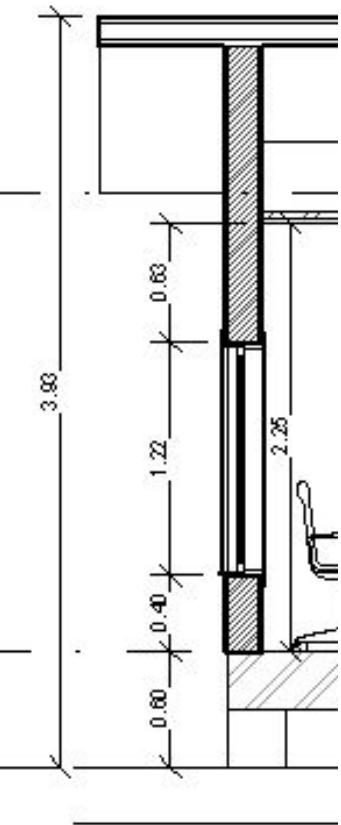

CORTES

- **Niveles**
- **Cotas**
- Nombres recintos
- M2

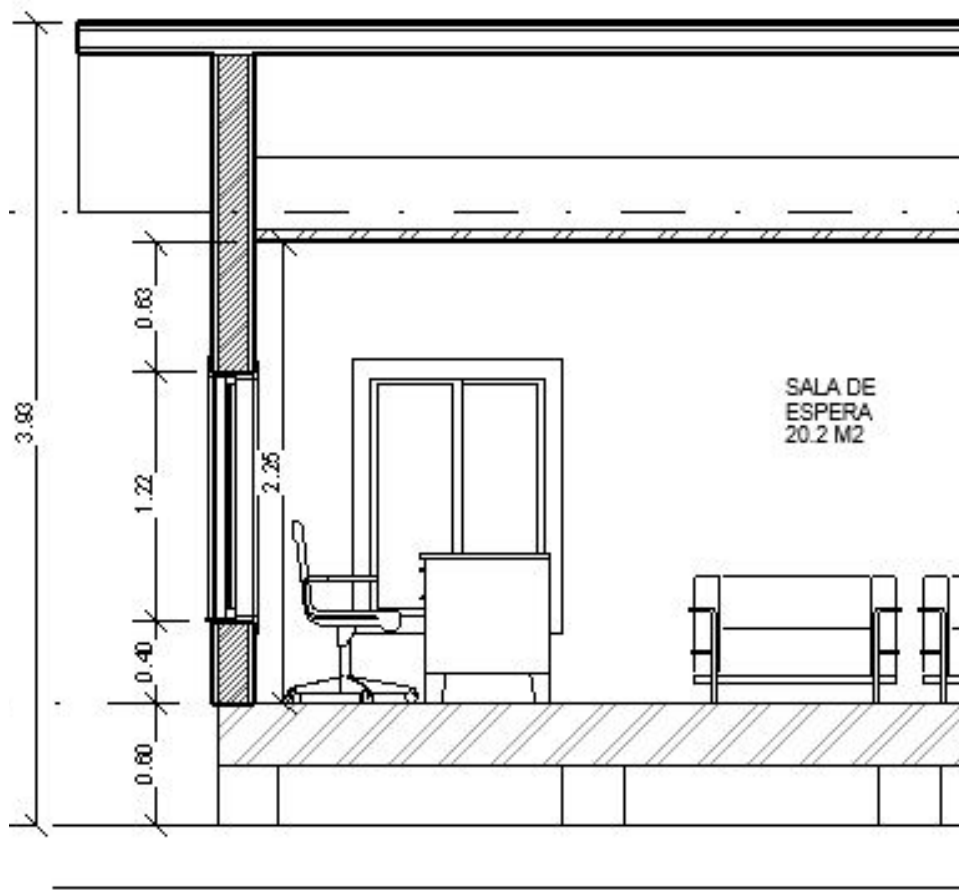

CORTES

- Niveles
- Cotas
- **Nombres recintos**
- **M2**



VIÑETA

- Nombre proyecto
- Nombre Arquitecto@
- Contenido (planta, corte, etc.)
- Unidades (cotas)
- Escala
- Norte
- Fecha

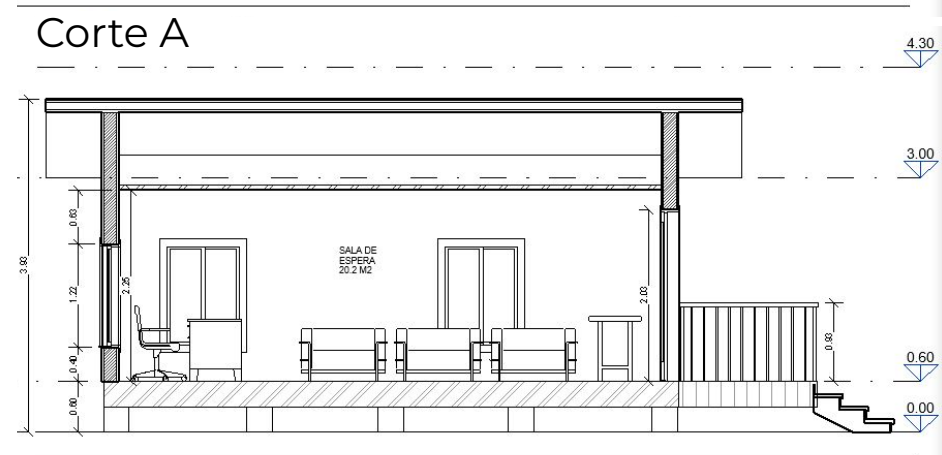
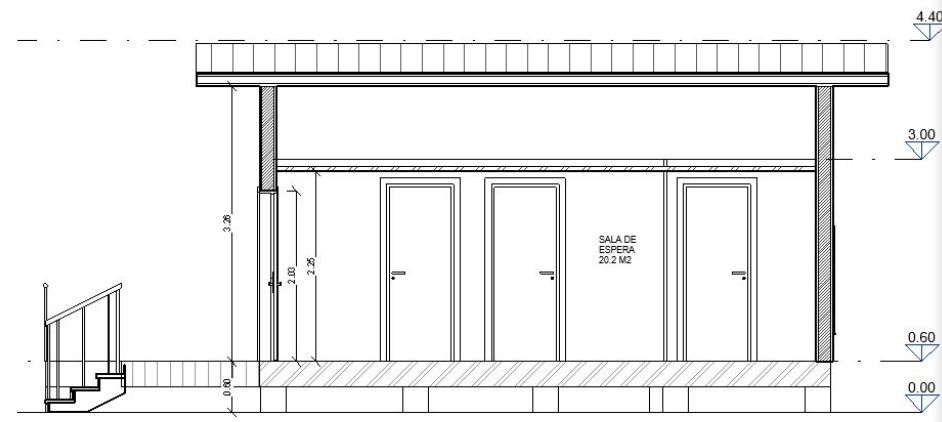
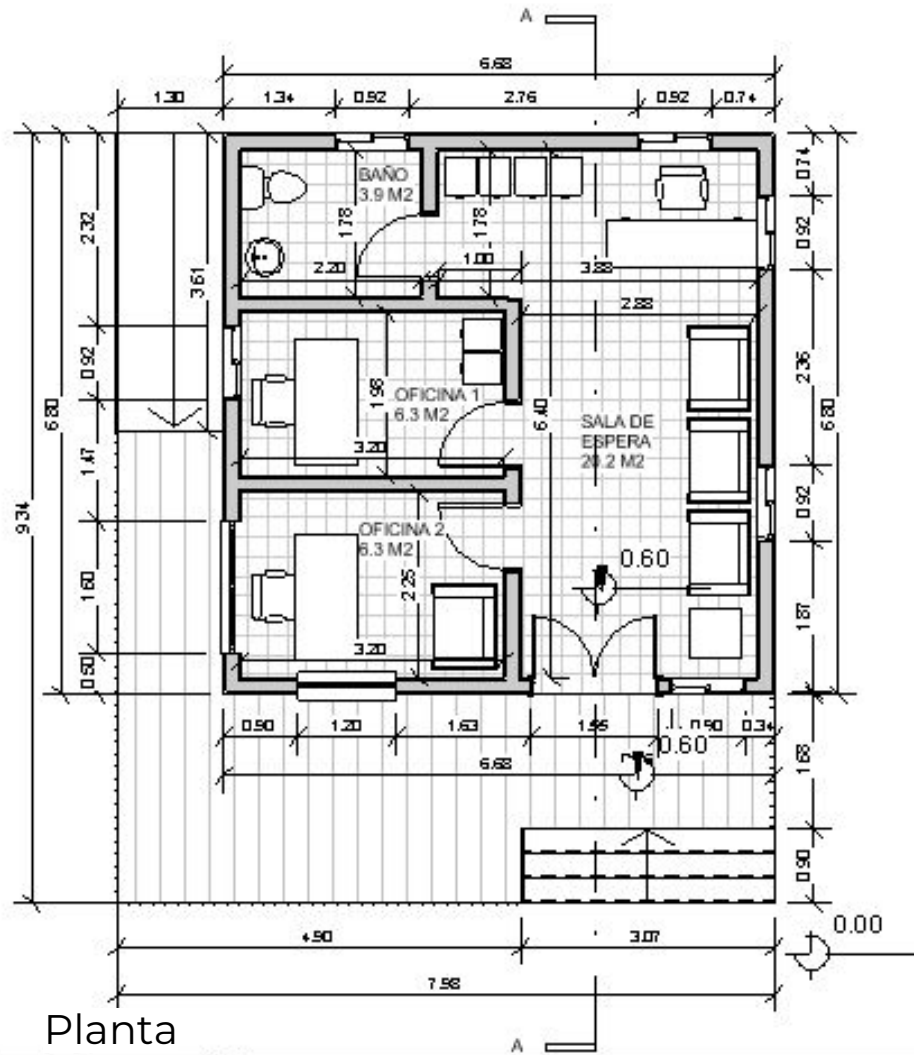

ENCARGO PLANIMETRÍAS

1. Planta:

- Escala 1:50
- Materiales: Hilado 9 y portaminas.
- Lámina 77 x 55 cm
- Viñeta
- Debe incluir caseta ascensor y proyecto exterior.

2. Corte:

- Escala 1:50
- Materiales: Hilado 9 y portaminas.
- Lámina 77 x 55 cm
- Viñeta
- Debe incluir caseta ascensor y proyecto exterior.