

Elevación A  
esc 1:20

- ESTRUCTURA (LUNA)
- VIDRIO (VIGAS)
- OXIDEPA

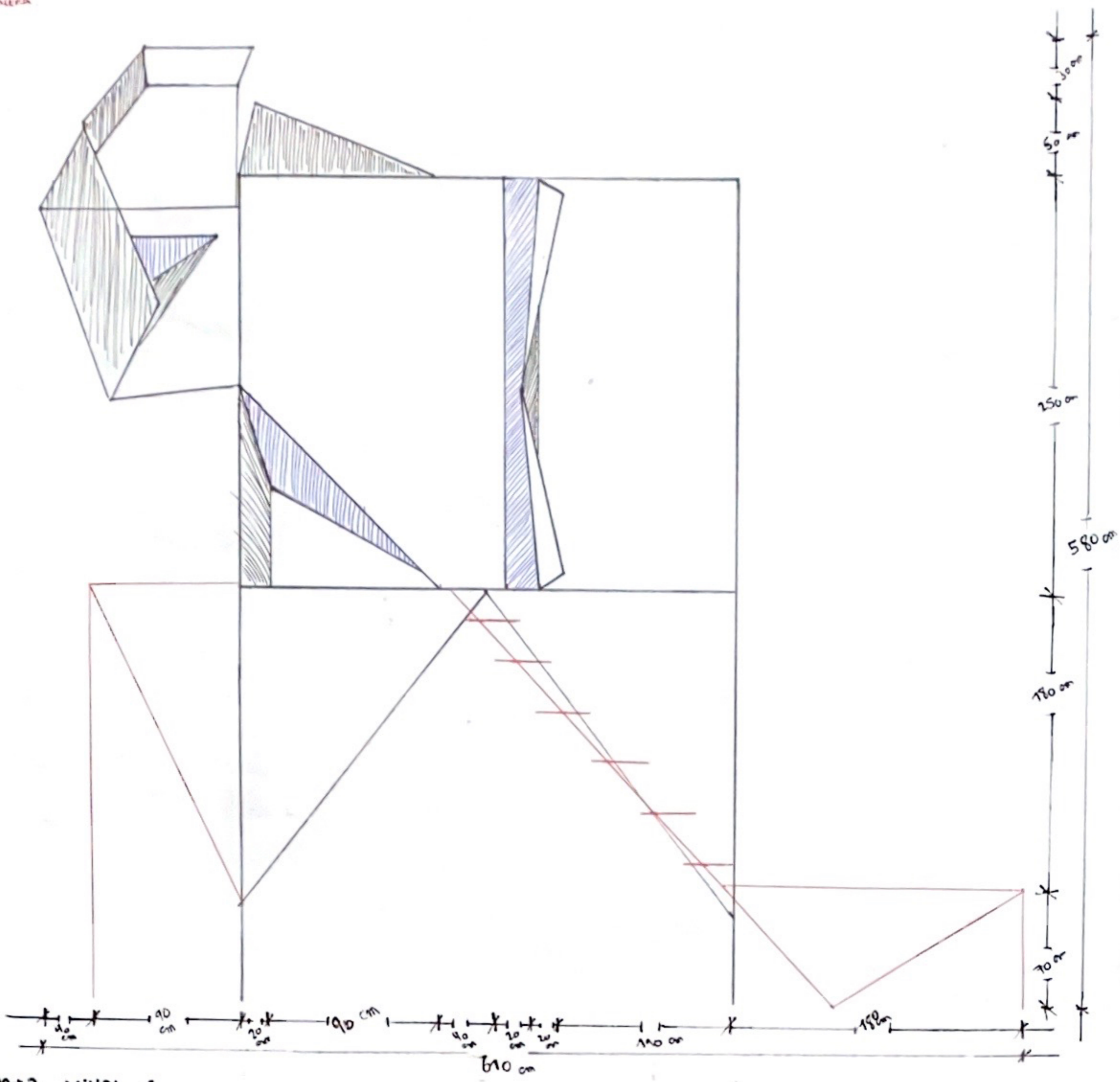

Planta Nivel 1  
esc 1:20

A

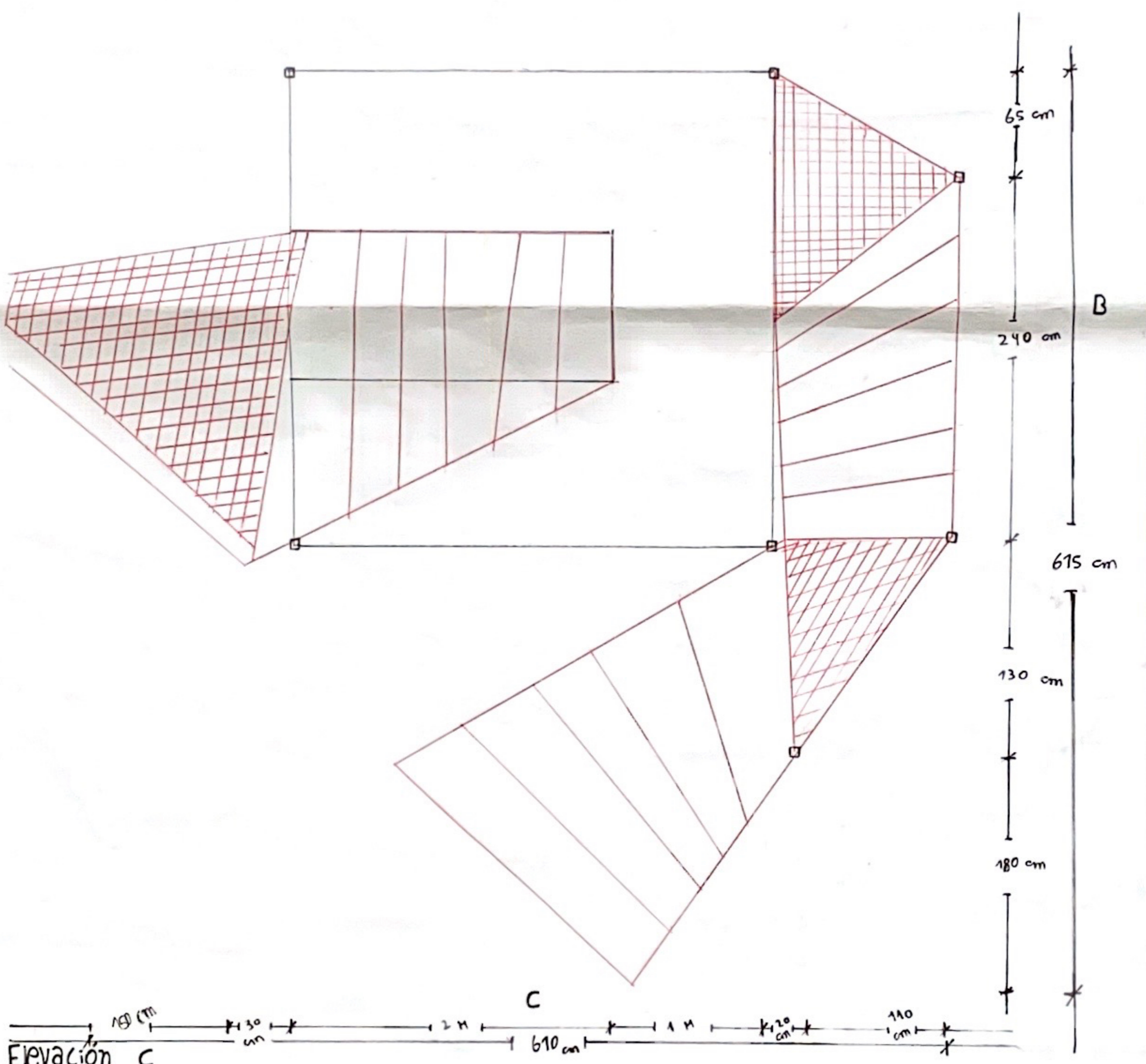

Elevación C  
esc 1:20

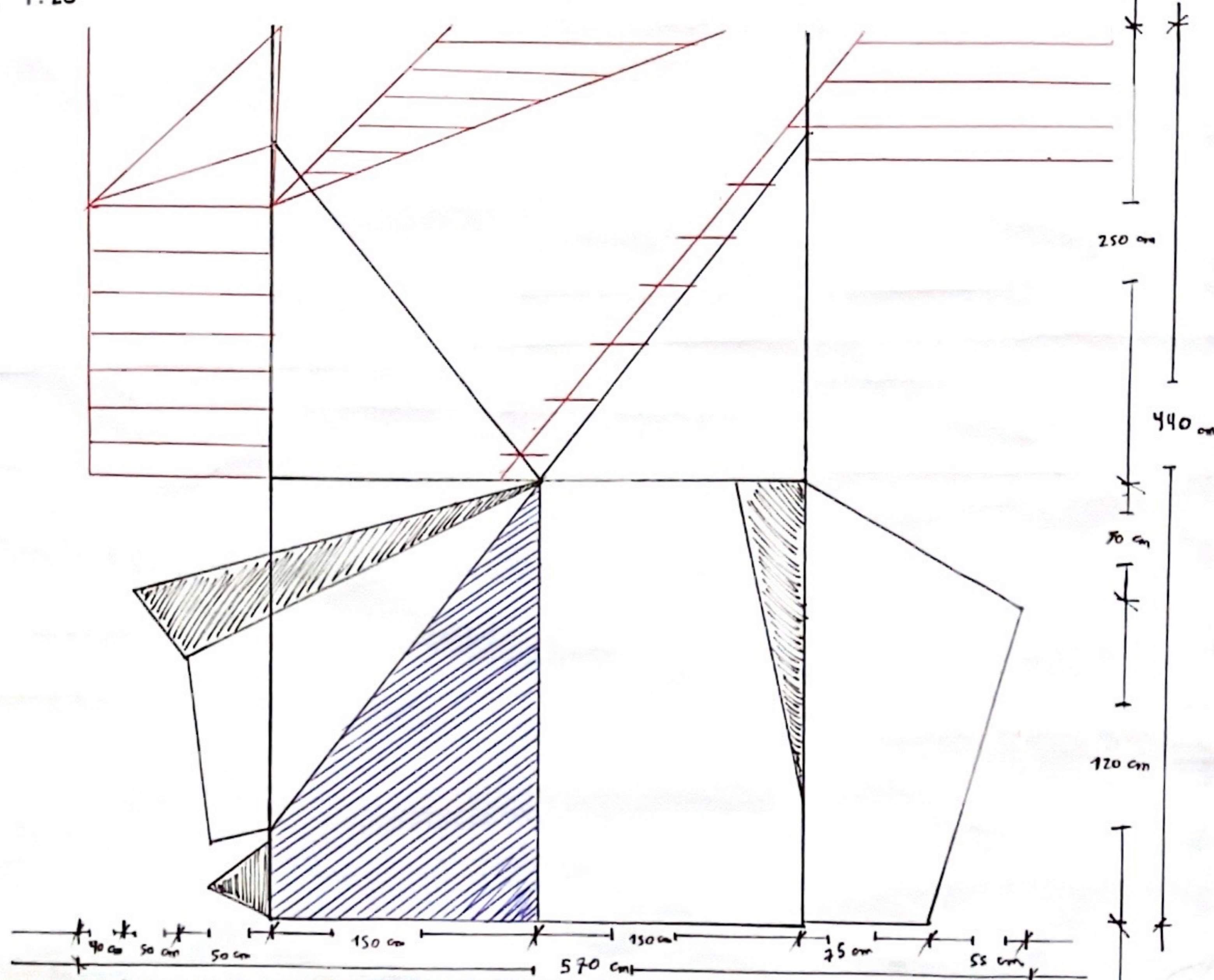

CORTE 1 A-A'  
 ESC 1:20

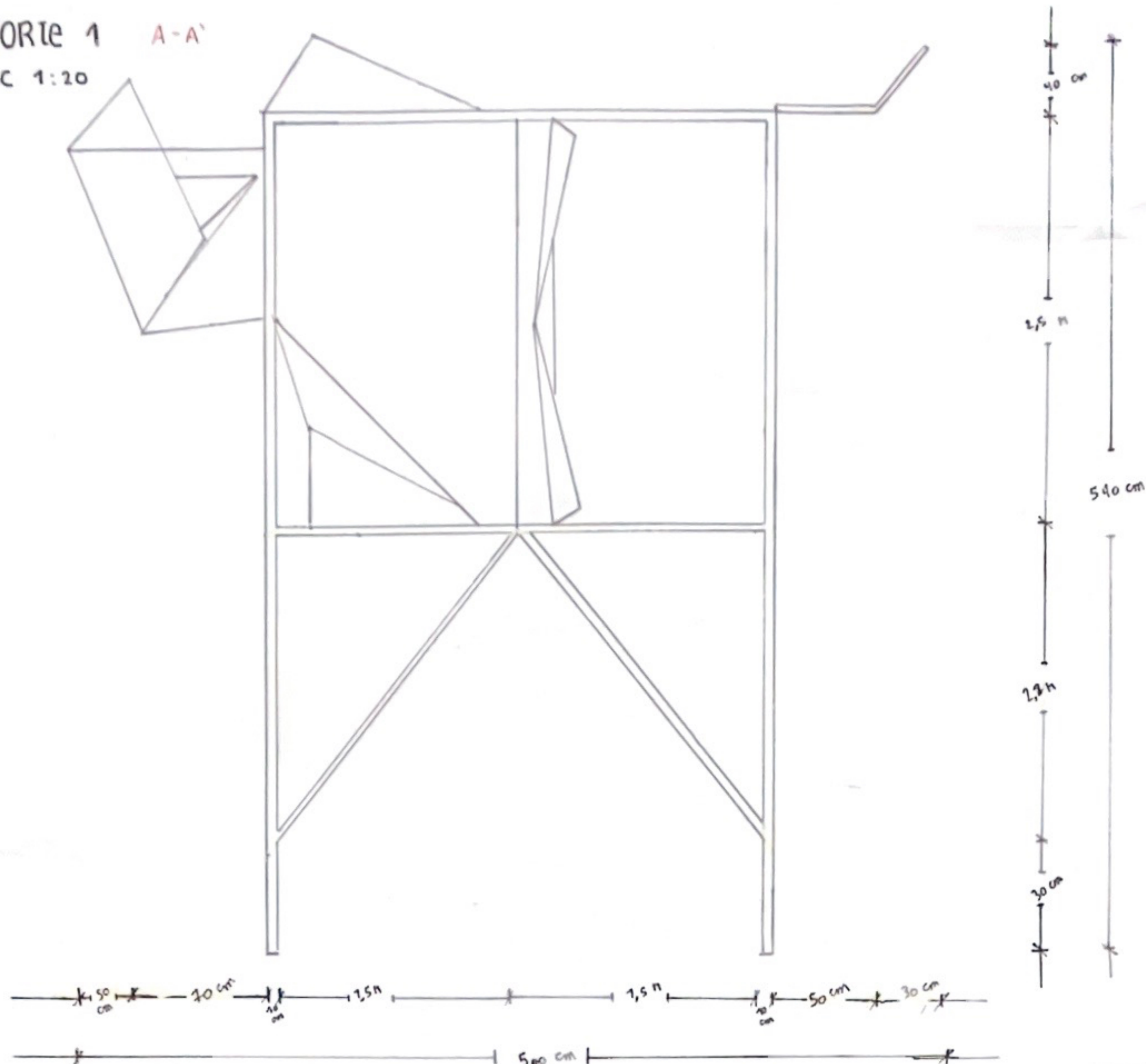

Planta nivel 2  
 ESC 1:20

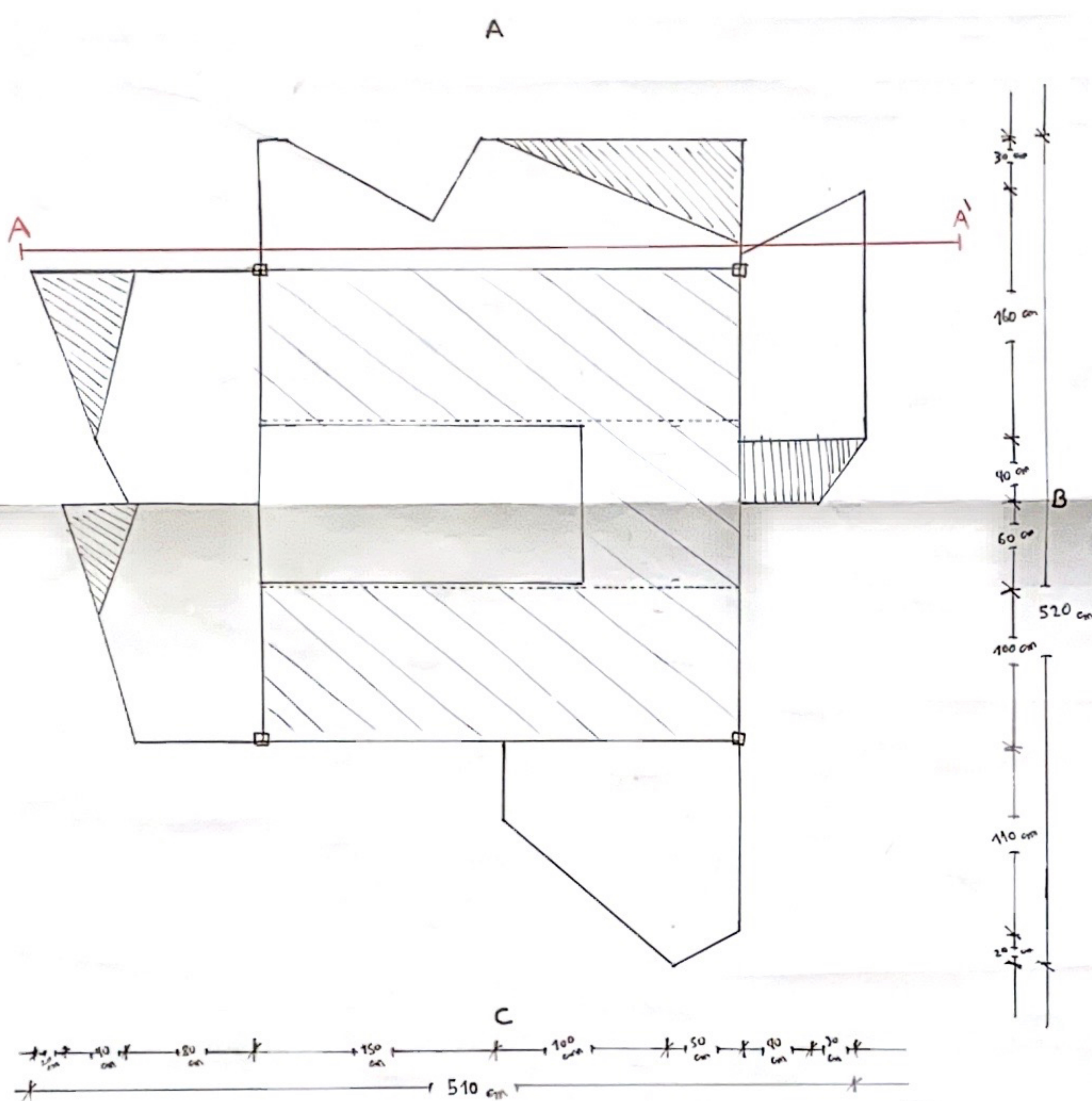

ACTO

—∴ Detenerse en la luz.

LUZ ARRIBA

—∴ Direccionalada.

LUZ ABAJO

—∴ Difusa.

CENTIMETROS  
 Lineales

—∴ 900 cm.

Elevación B  
 ESC 1:20

- ESTRUCTURA (LIGRO).
- MOBILIO (VACIO).
- ENCLAVADA.

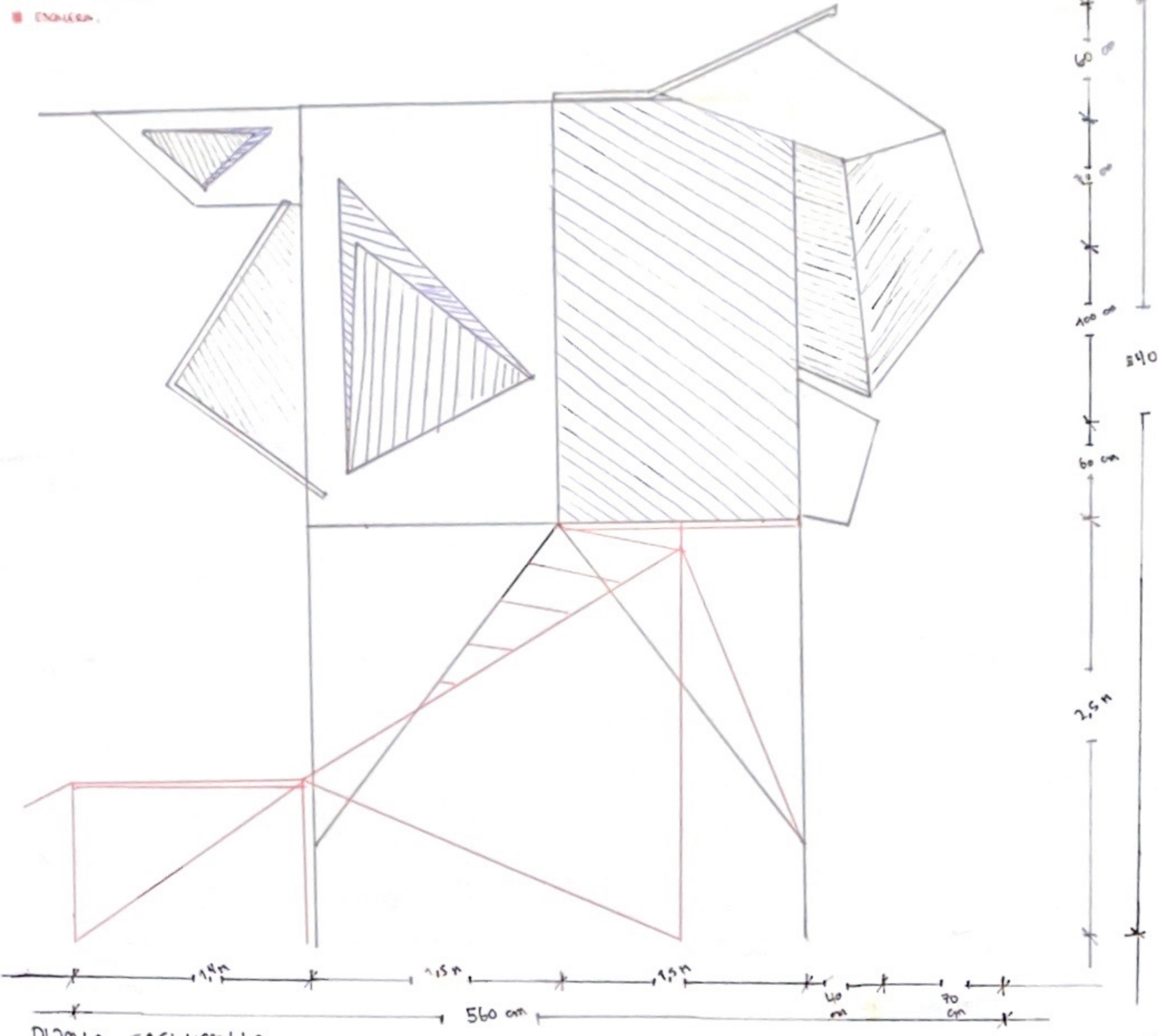

Planta techumbre  
 ESC 1:20

B

A

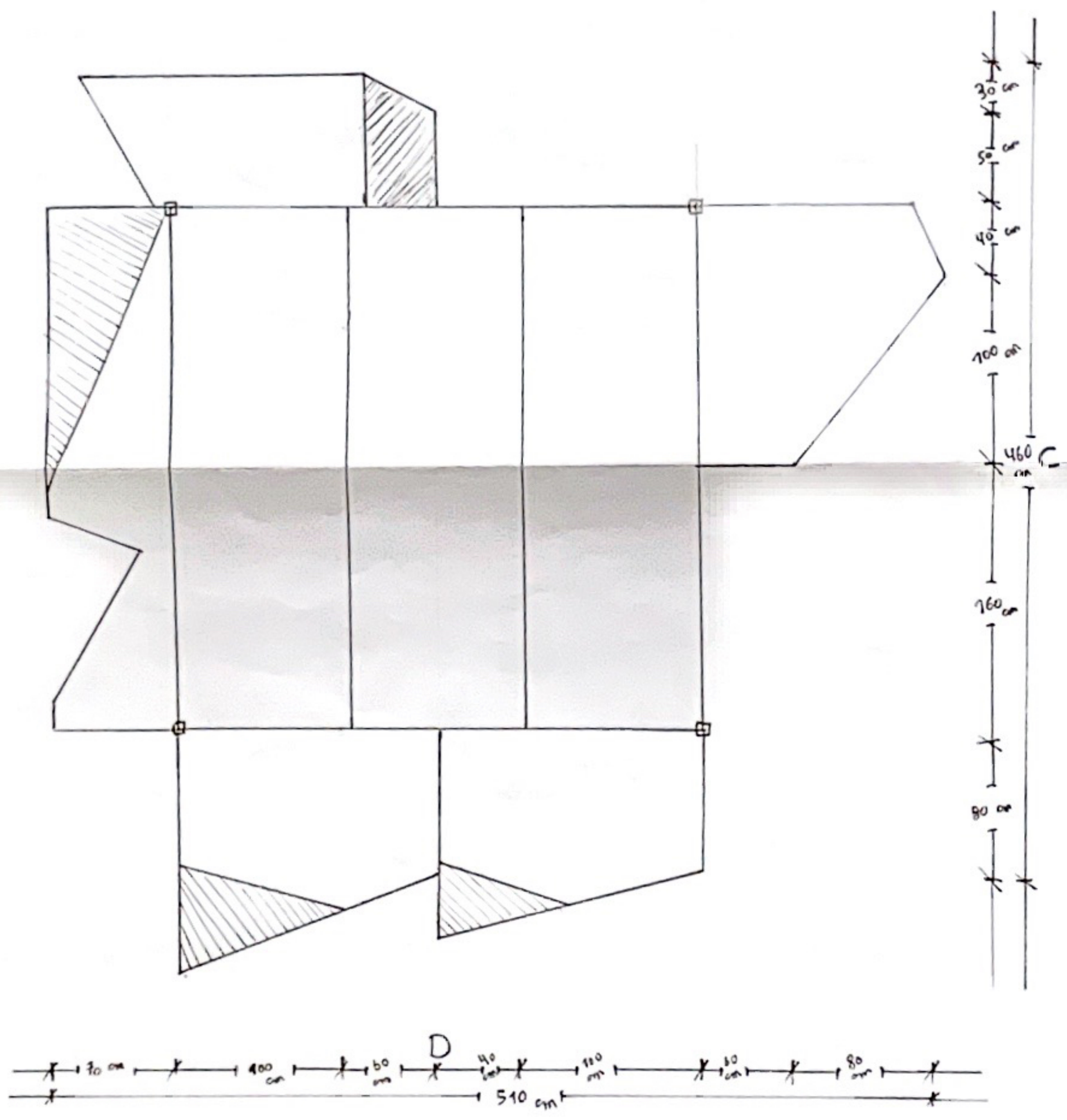

Elevación D  
 ESC 1:20

