

no p

La persona busca el ángulo de visión.

Estudia deformaciones de luz

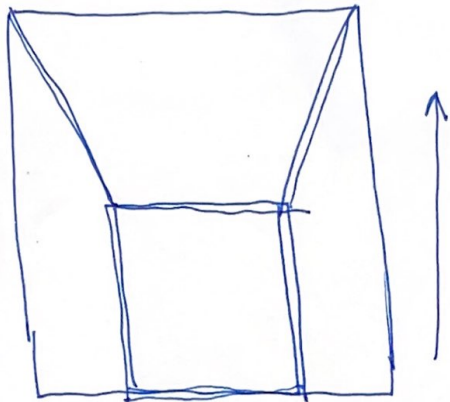

↓  
espejo flotante

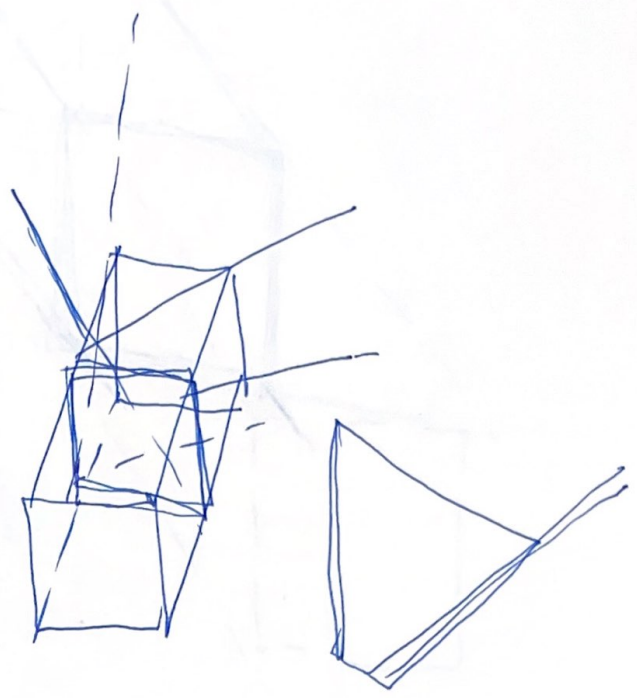

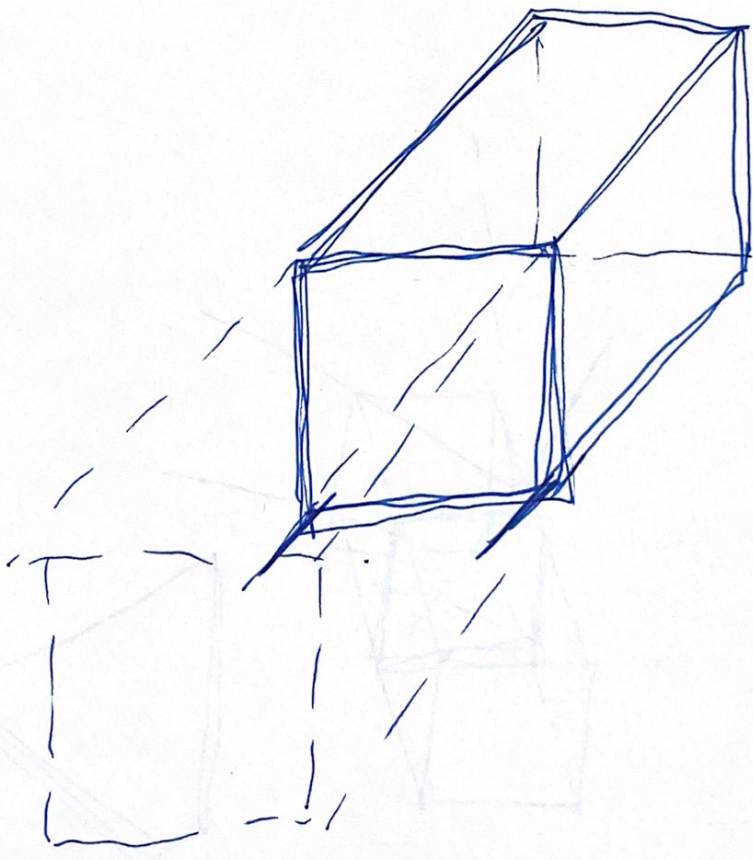
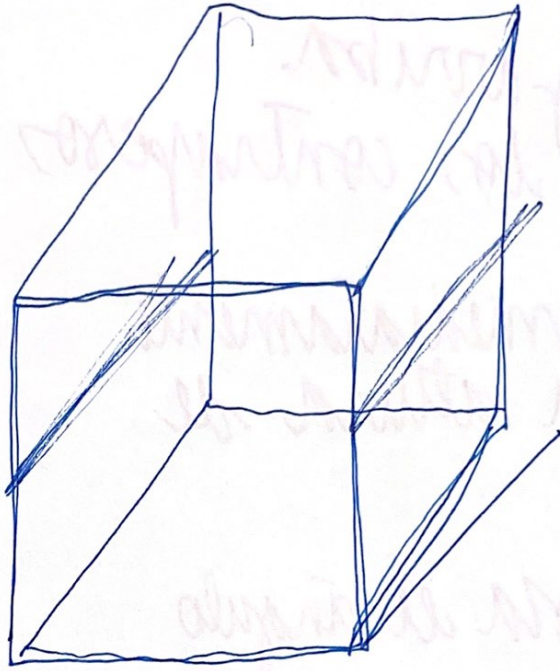

Handwritten notes in red ink, mostly illegible due to blurring and bleed-through. Some discernible words include "factors", "of", "the", "structure", "of", "the", "system", "is", "based", "on", "the", "interaction", "of", "the", "various", "components", "and", "the", "overall", "behavior", "of", "the", "system".

Handwritten notes in red ink, mostly illegible. Some discernible words include "structure", "of", "the", "system", "is", "based", "on", "the", "interaction", "of", "the", "various", "components", "and", "the", "overall", "behavior", "of", "the", "system".

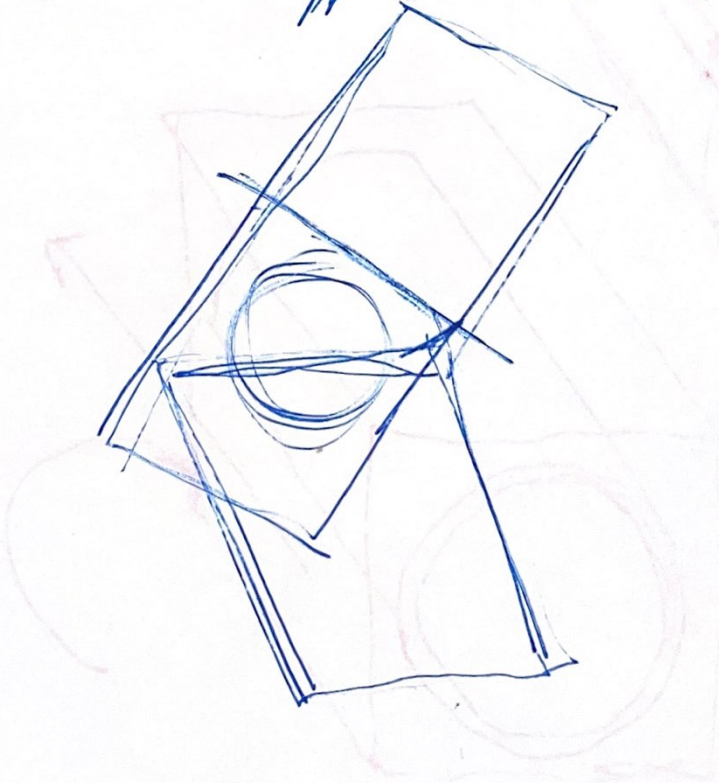
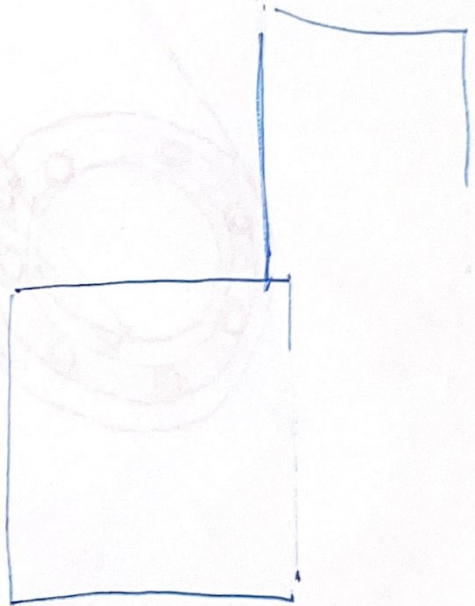
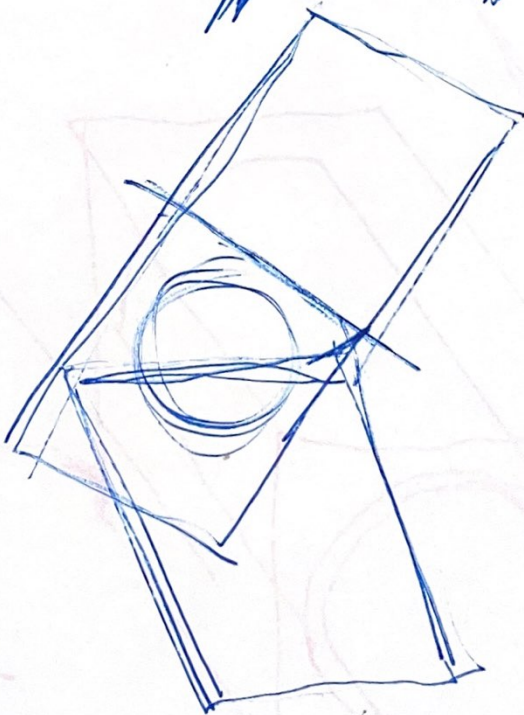
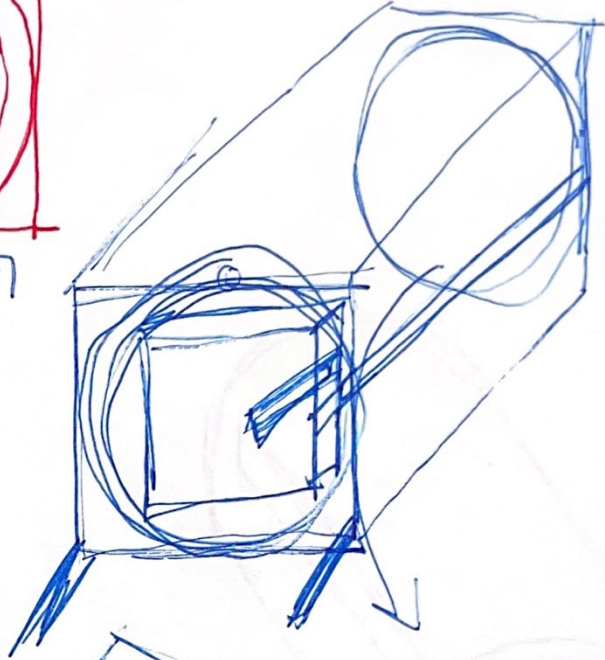
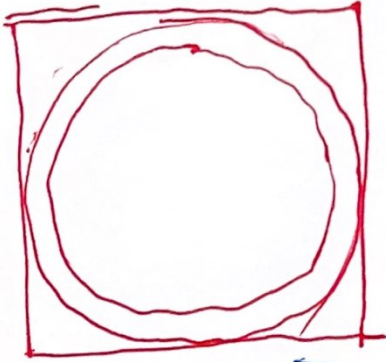

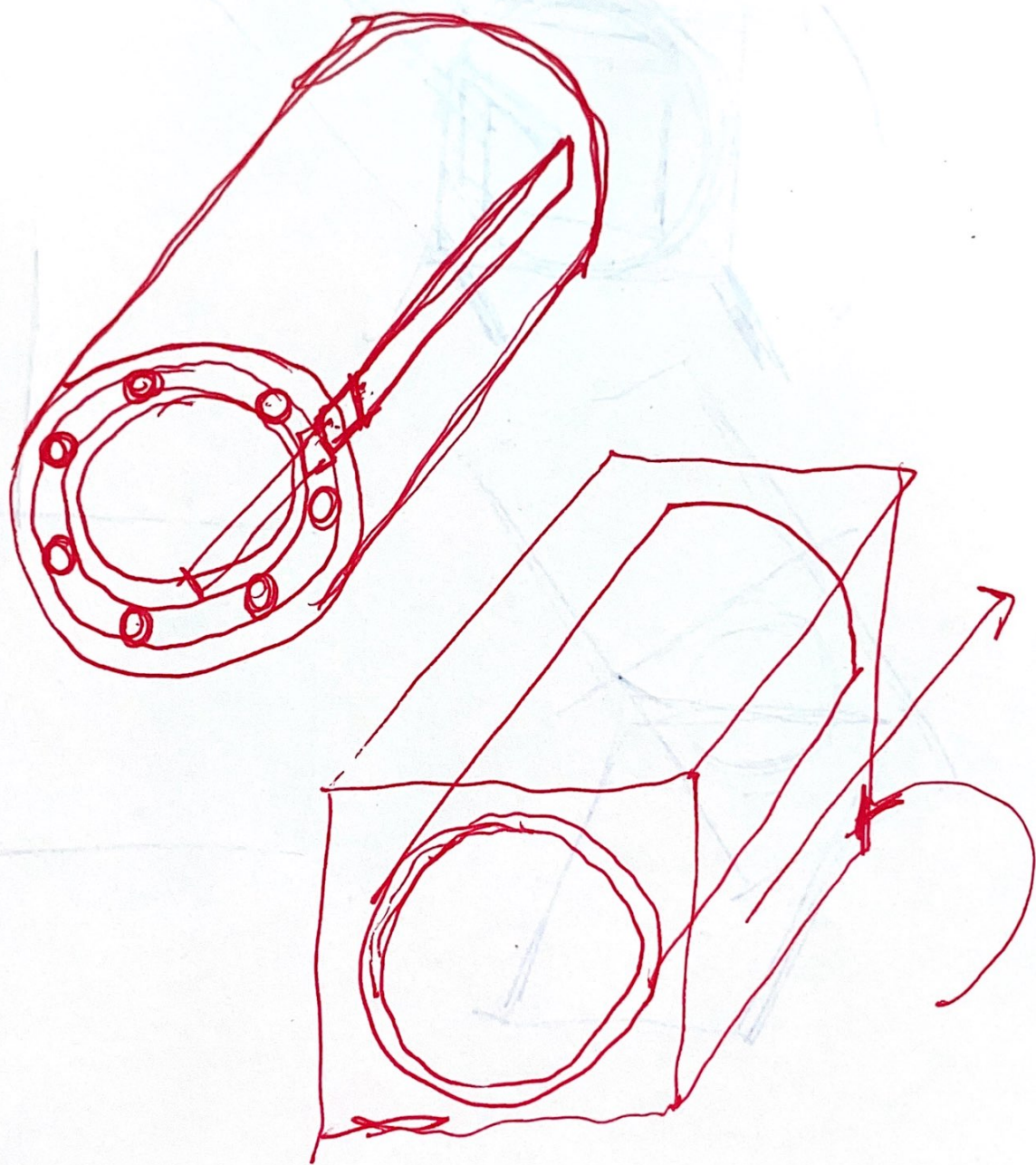

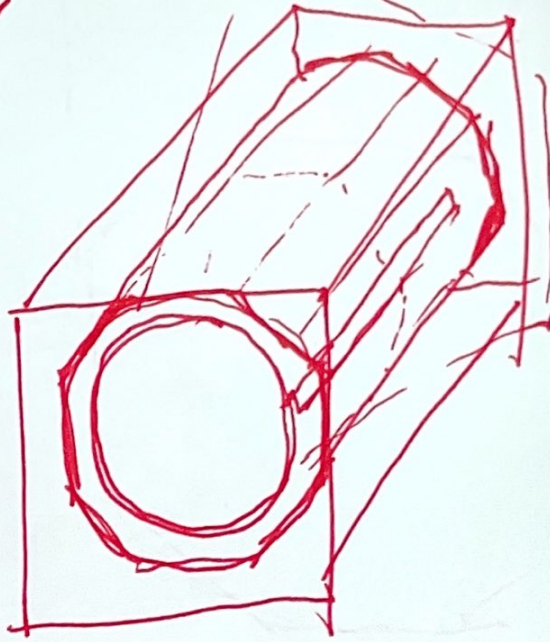
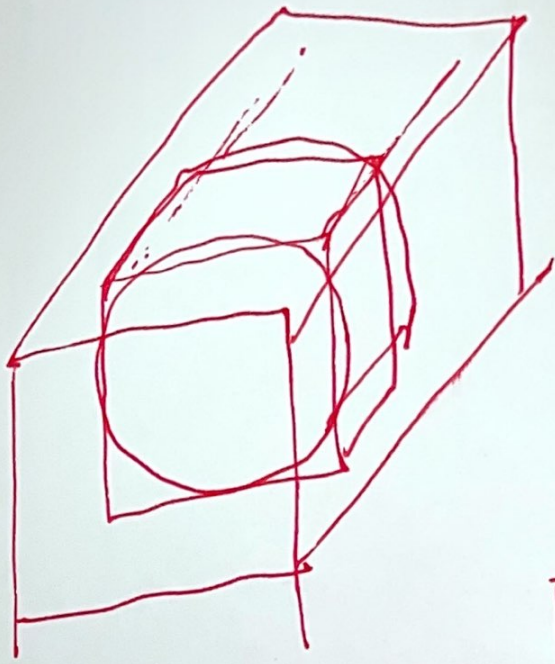

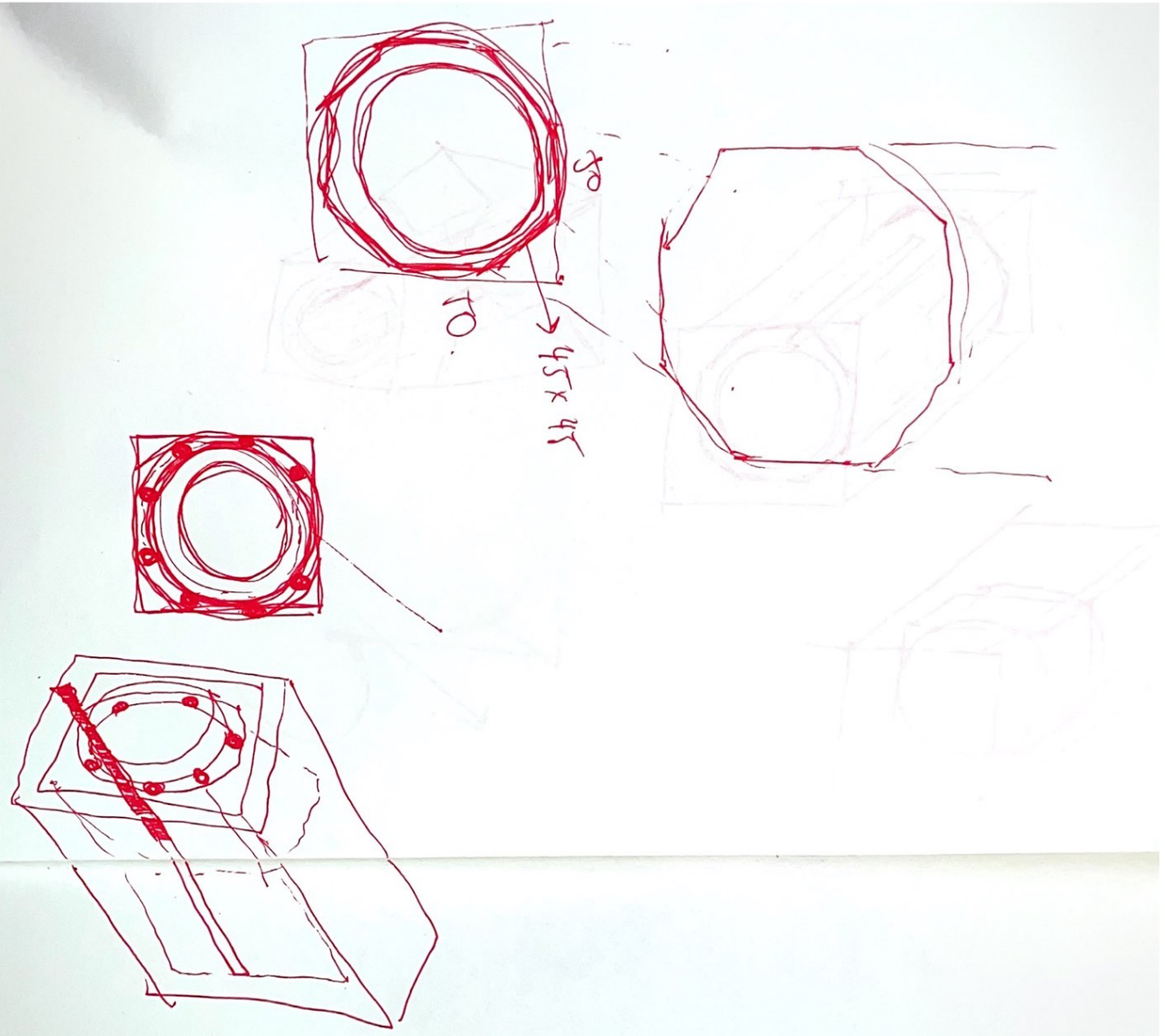

Orbita 1,5 = 5 support

M

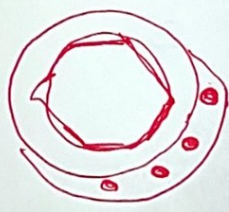
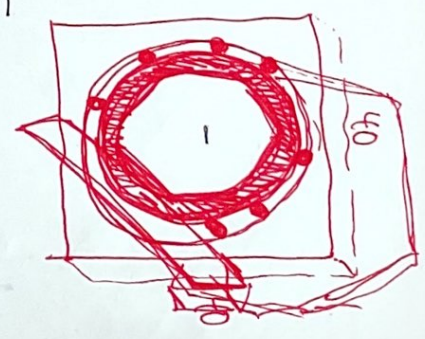

manana compran!

- 1x2
- 1x1/3 (2)
- sequencias
- tela.

blusa  
caletas  
falda  
ferrule  
lana  
mantillo

Handwritten text at the top left, possibly a title or reference number, including the number 211.

Handwritten text in the upper middle section, possibly a label or identifier.

