

ENCARGO 09 | DOS SABORES Y SOPORTE CON LA COPA

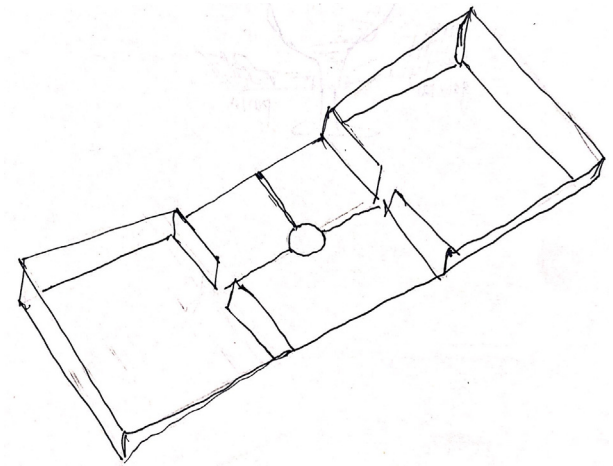

ENCARGO 10 | SOPORTE EN LA COPA

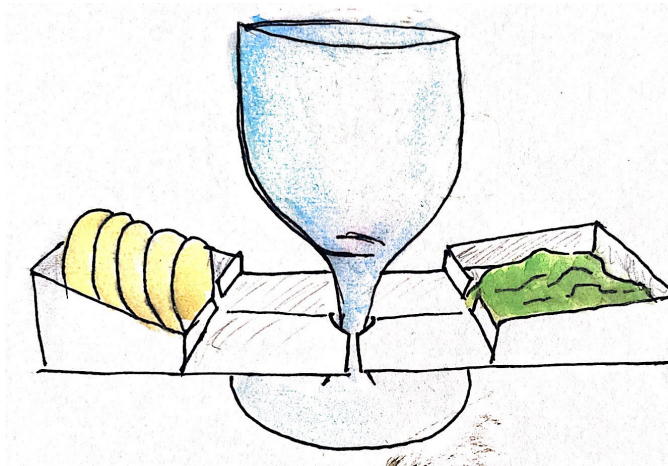
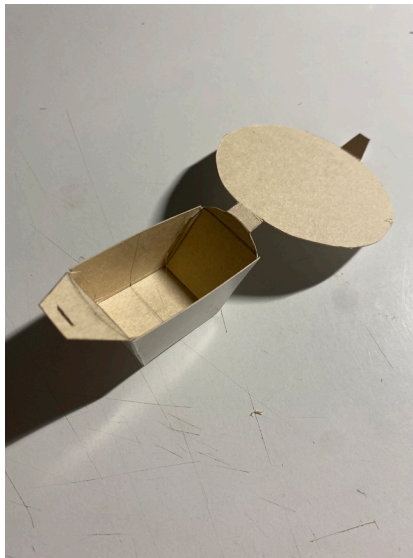
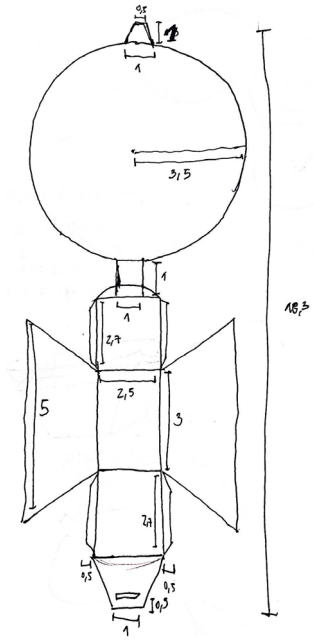
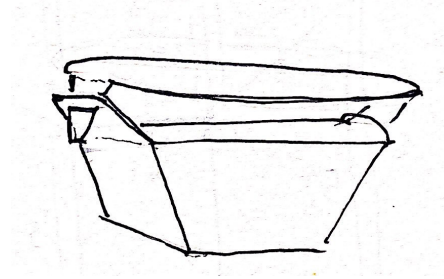
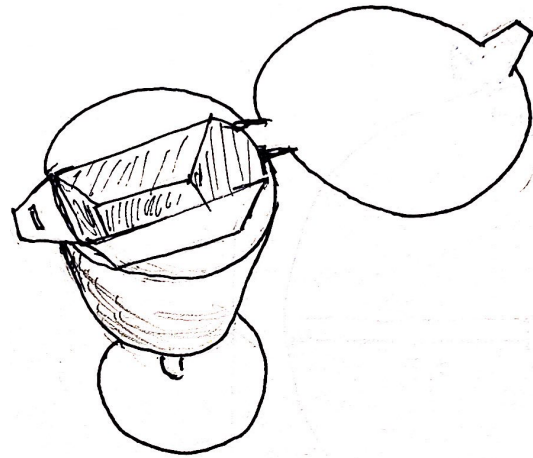

ENCARGO 11 | TRES COPAS CON PORTABOCADO Y SU SOPORTE

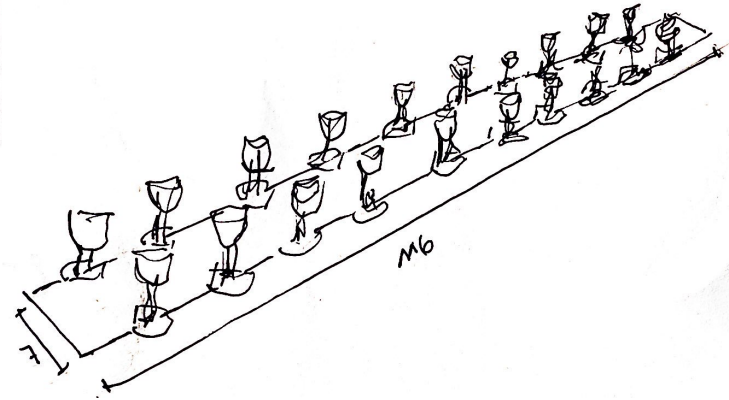
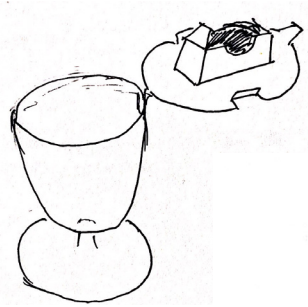
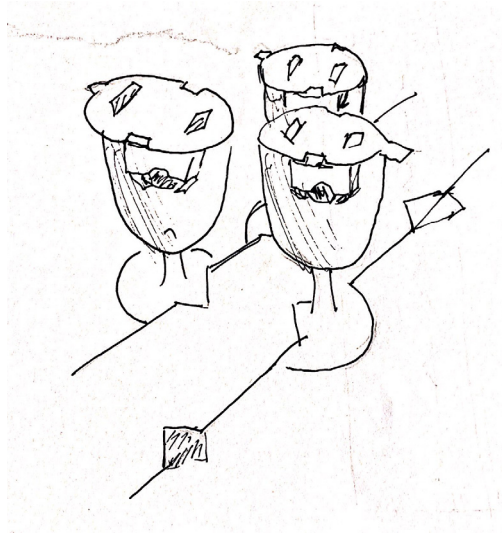

ENCARGO 12 | VASOS, PORTABOCADO Y SOPORTE; DESAYUNO

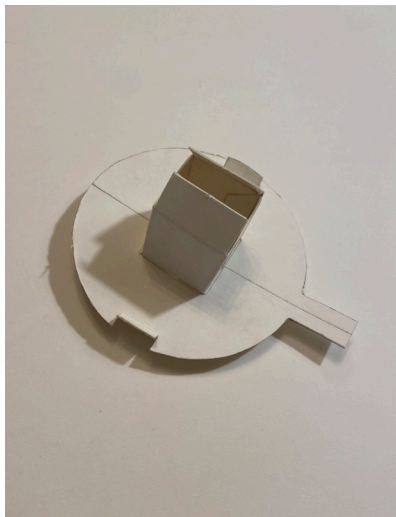
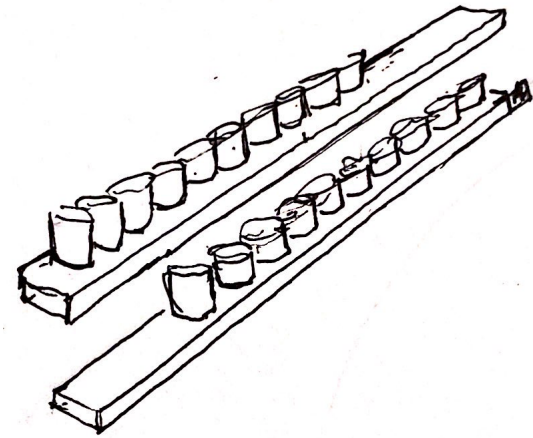
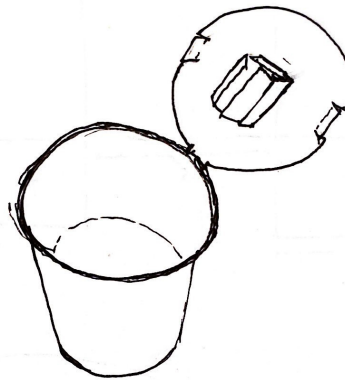
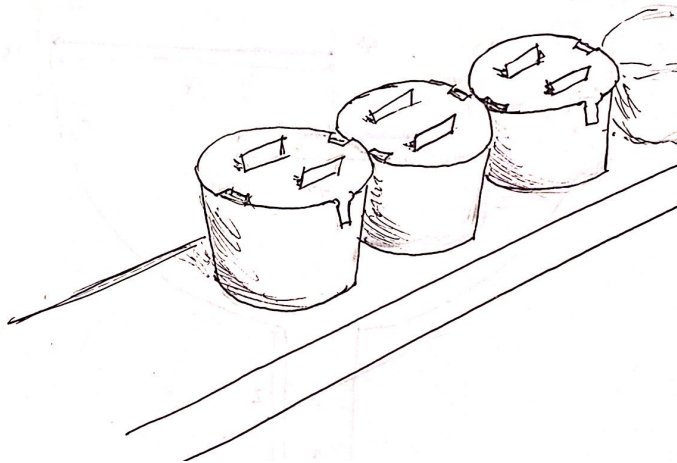

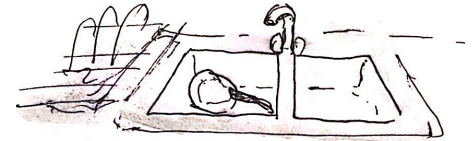
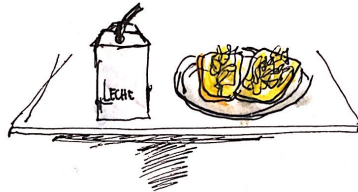
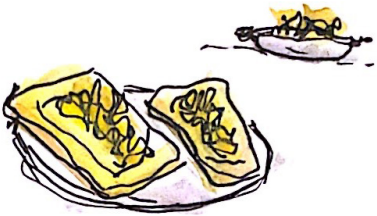
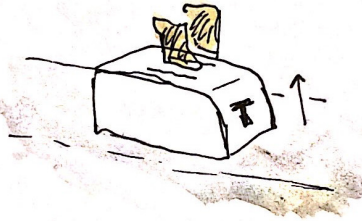
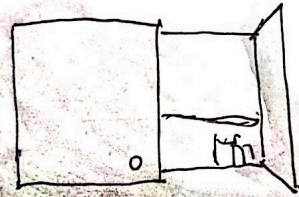
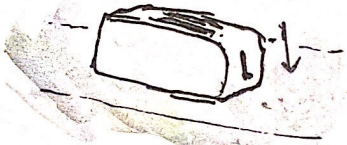
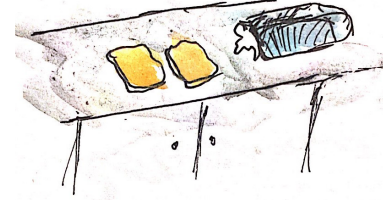
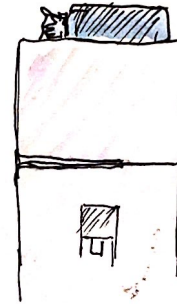

ENCARGO 13 | VASOS, PORTABOCADO Y SOPORTE 2

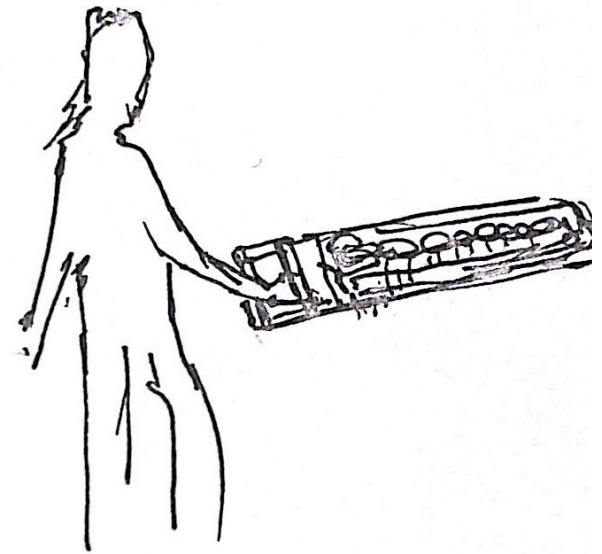
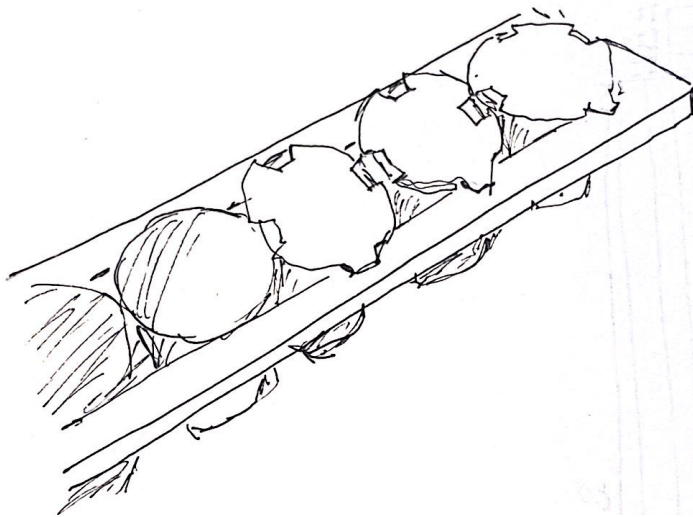

ENCARGO 15 | REGISTRO ACTO, ELEMENTO PORTABLE Y BOCADO TRIPLICADO

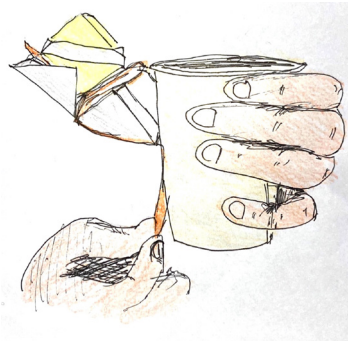
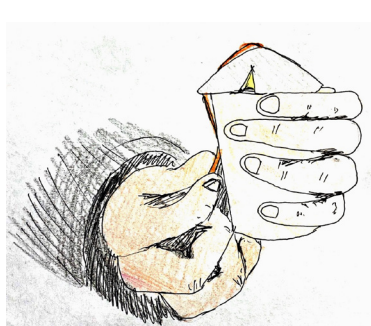
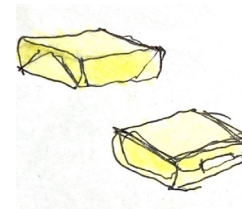
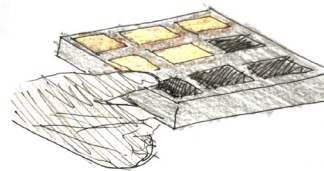
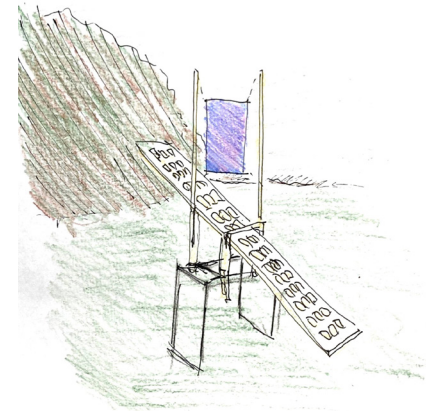
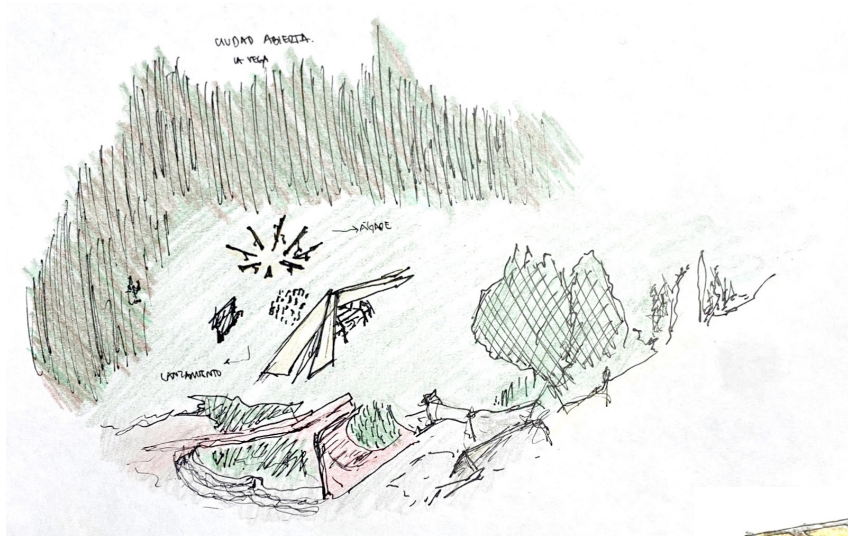

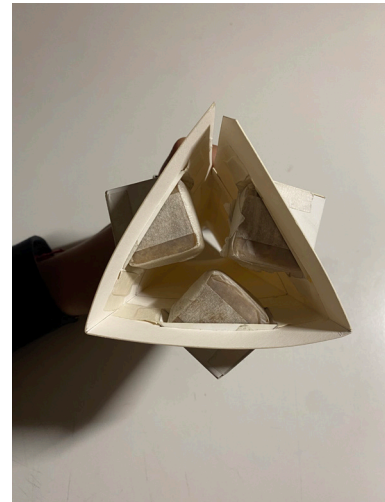
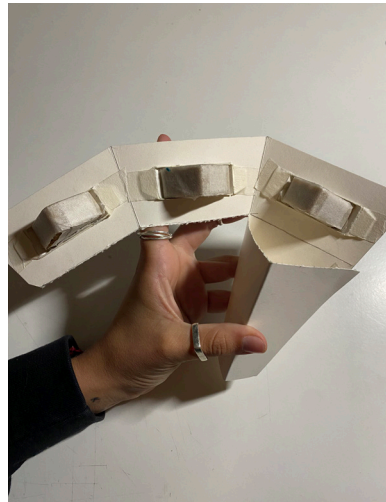
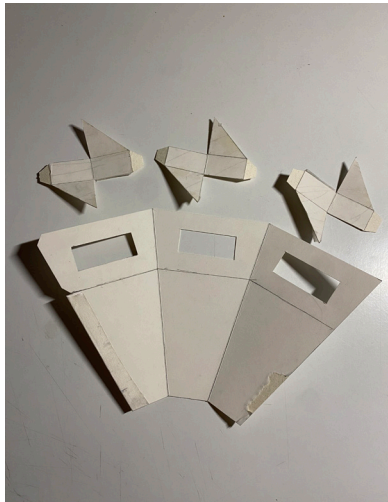
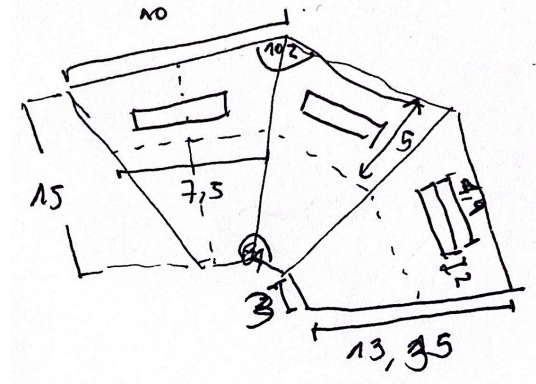
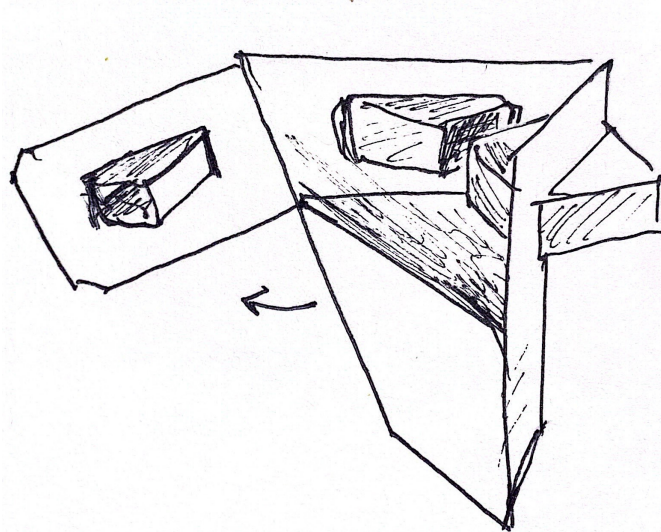
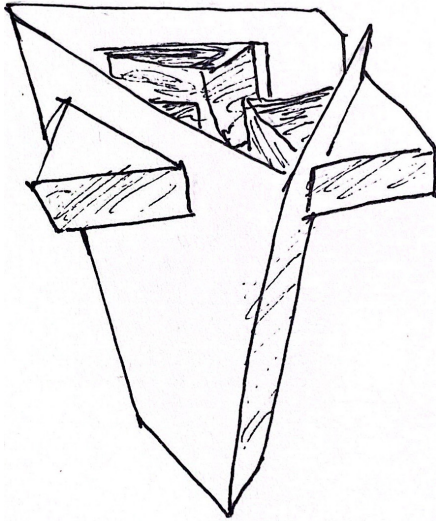

ENCARGO 16 | ELEMENTO PORTABLE Y BOCADO TRIPLICADO 2

