

PROPUESTA (DE FORMA) 'A' { el problema que no cumple }

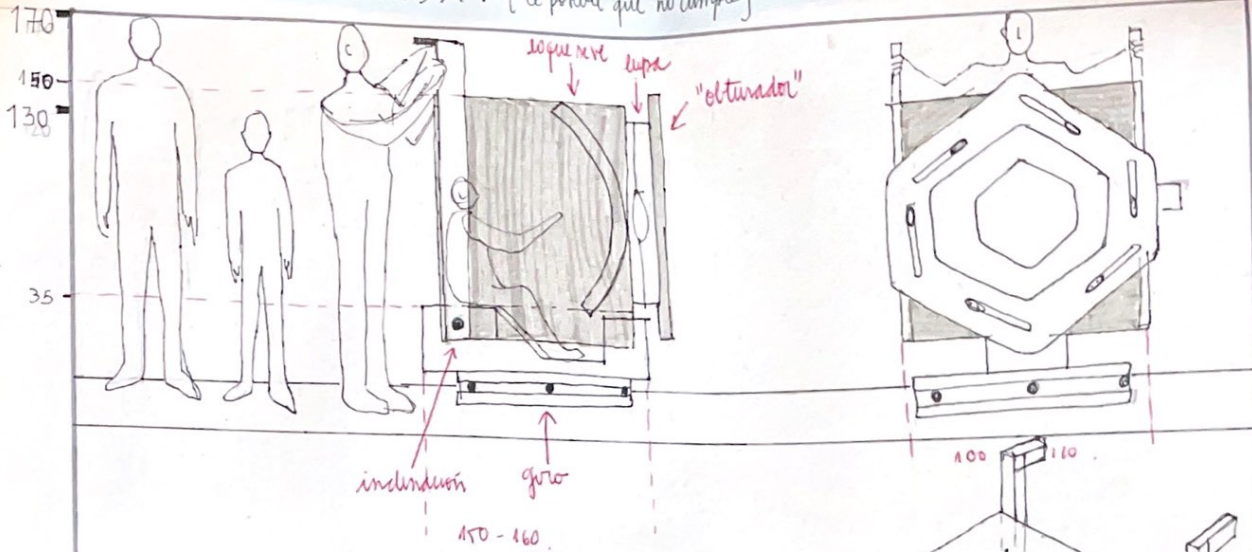

\*A

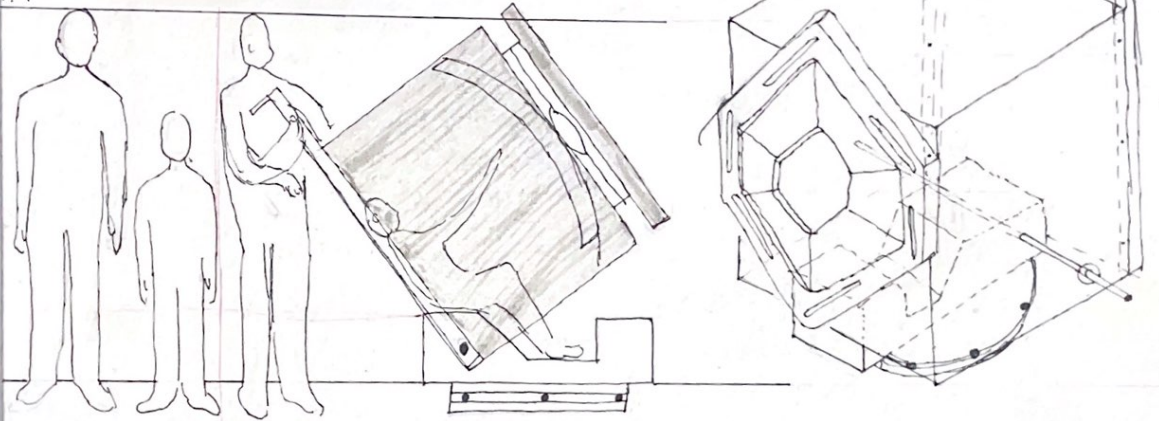

MECÁNICAS

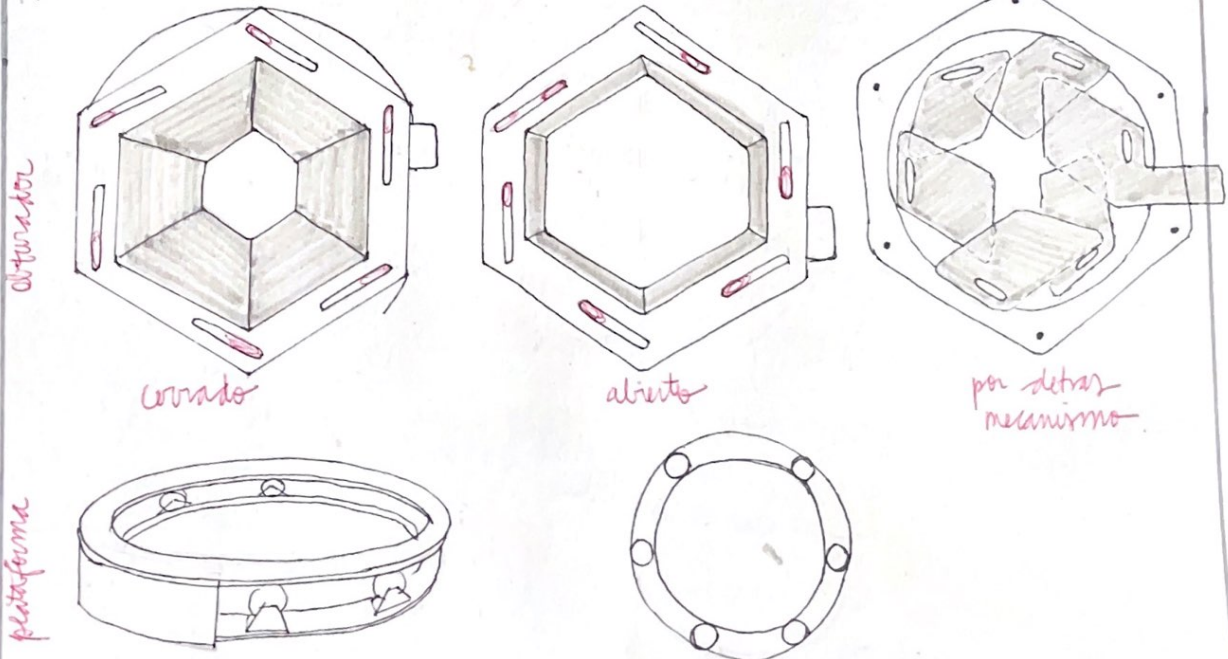

170

UNIDAD B (fórmula imposible)

130

35

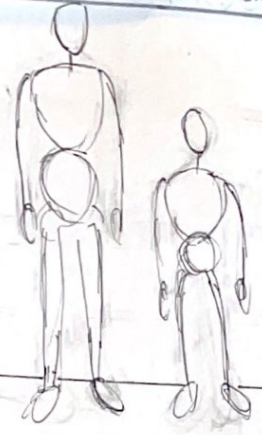

ventaja  
\* que ambas personas puedan ver

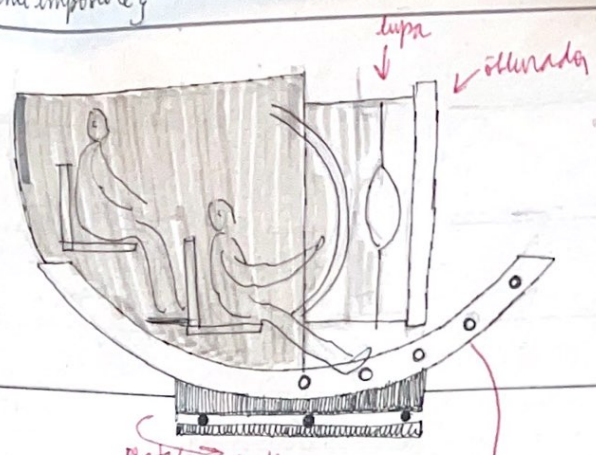

plataforma de gres

desventaja

inclinación es dado por empujar con las piernas los escalones.

\* imposible por la cantidad de fuerza aplicada

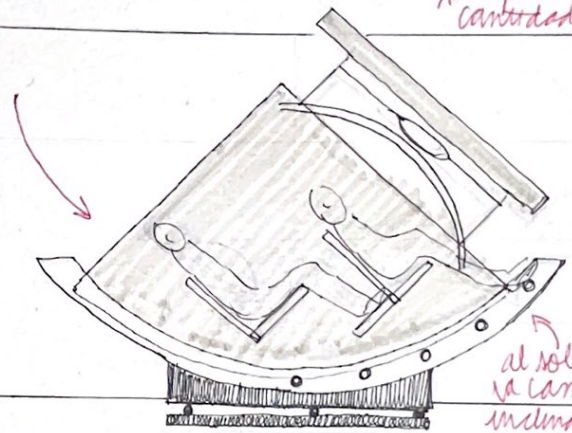
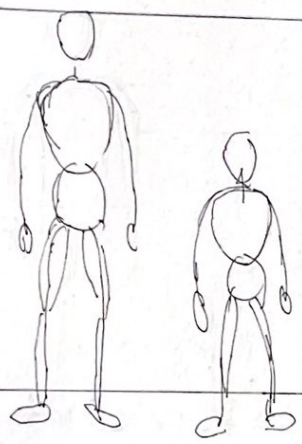

al soltar los escalones se cambian la inclinación.

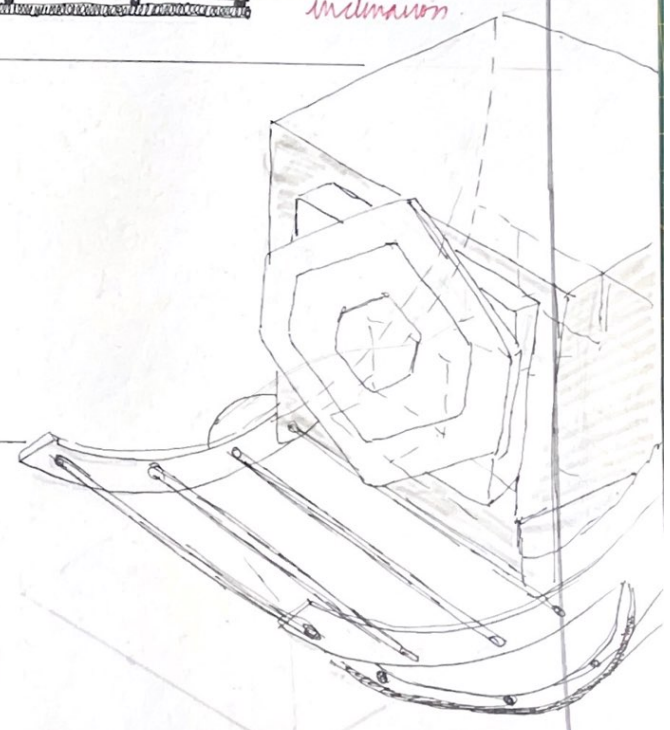
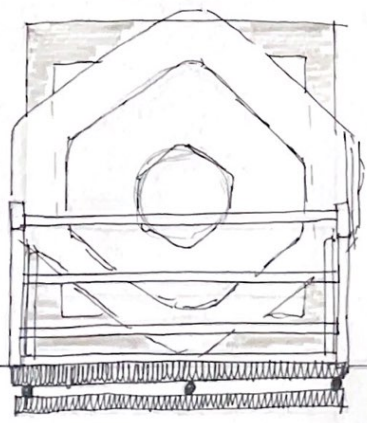

170  
50  
30

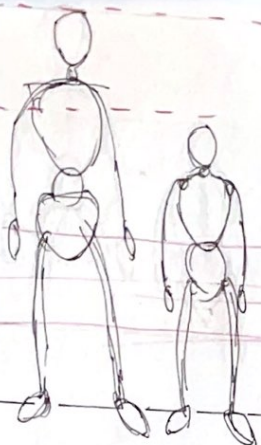

palanca que levanta la caja

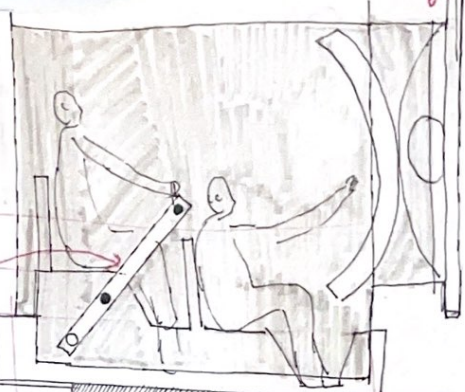

luz

obturador

giro

170

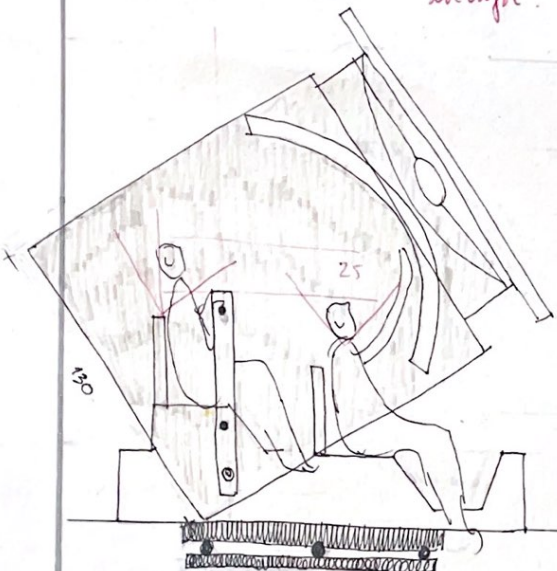

130

25

