

**ENCAJE PIEZA D Y C**  
1:4

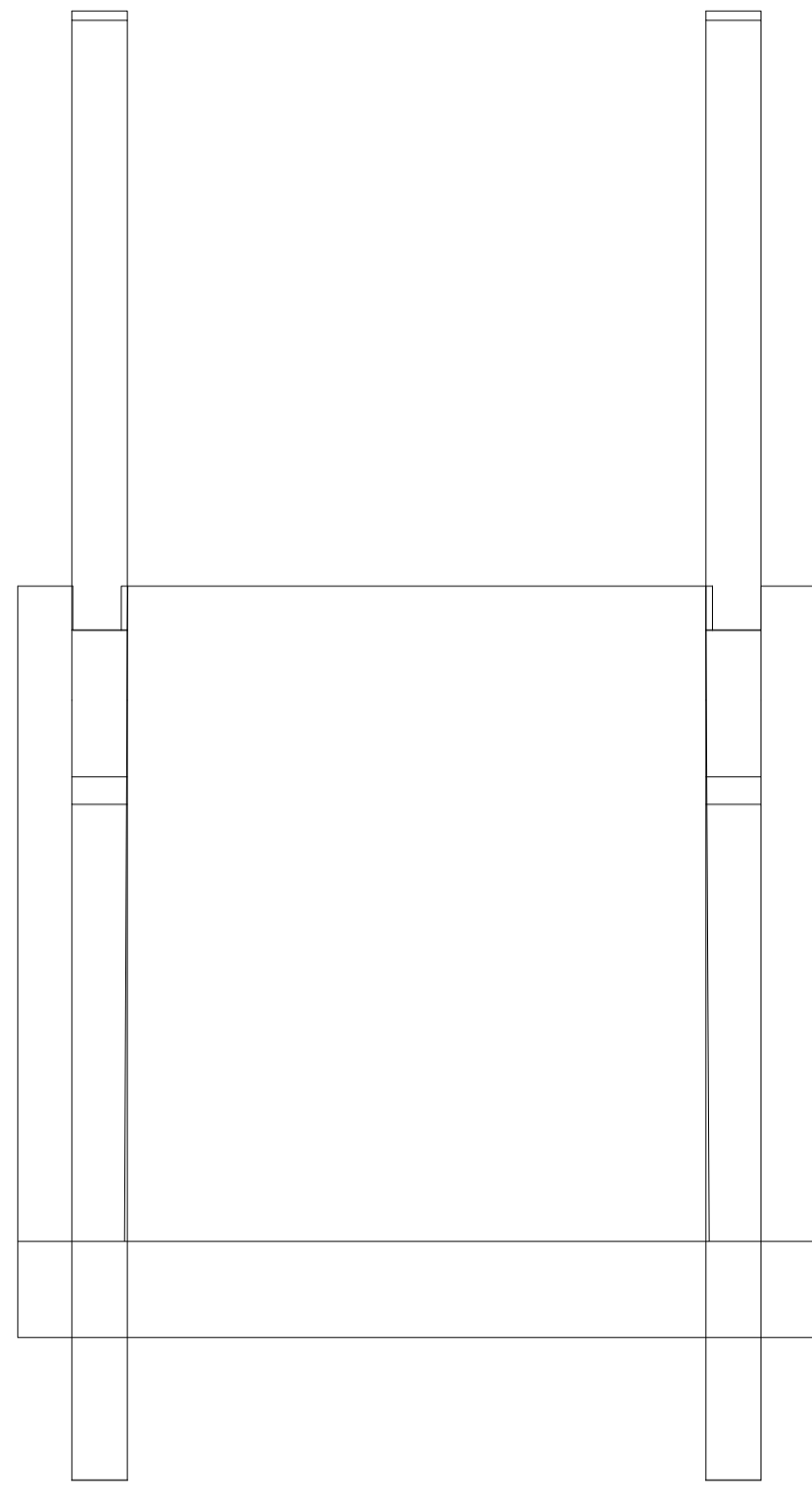

**ENCAJE ASIENTO Y RESPALDO**  
1:4

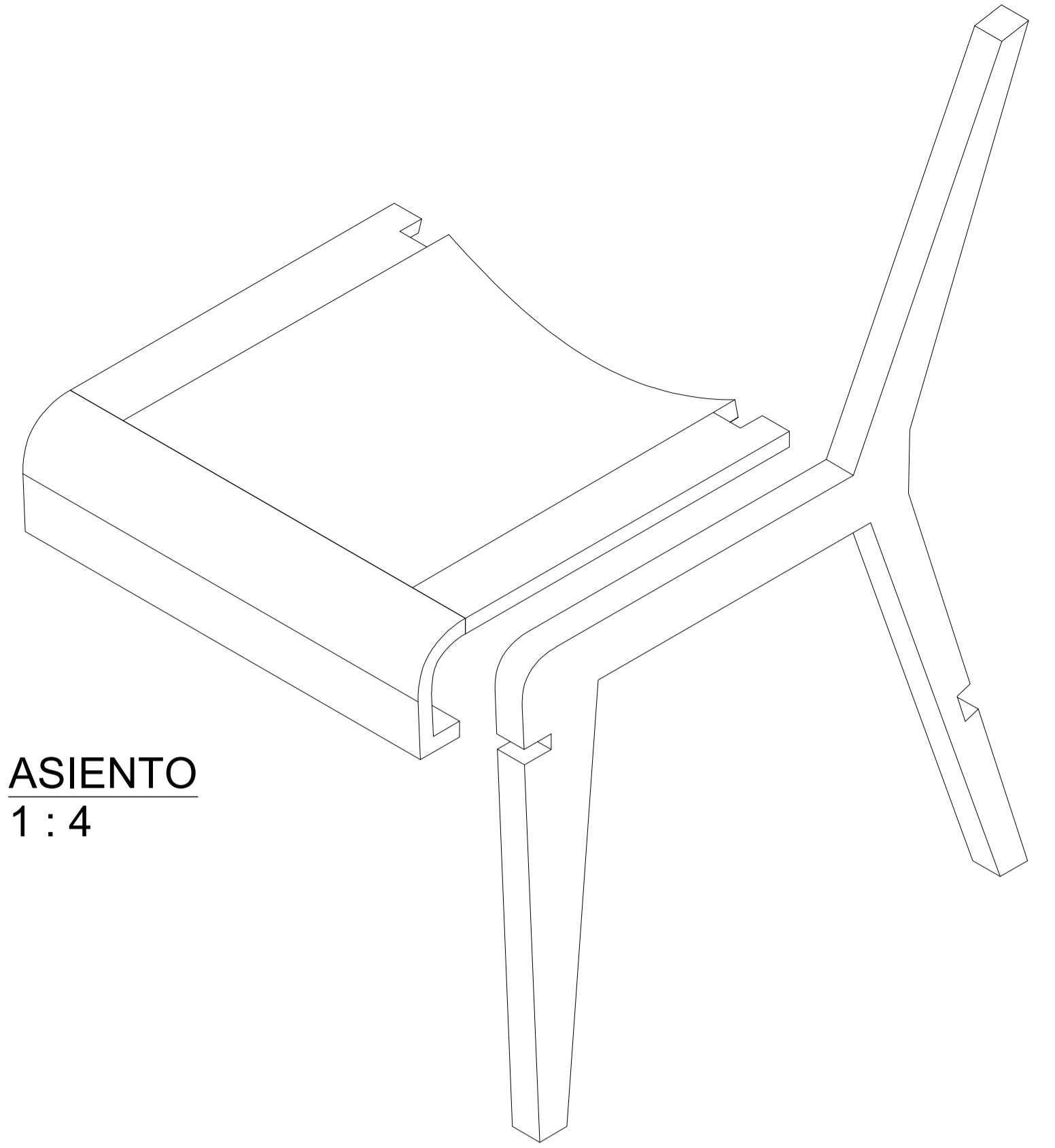

**ASIENTO**  
1:4

**PIEZA PATAS LATERALES**  
1:4

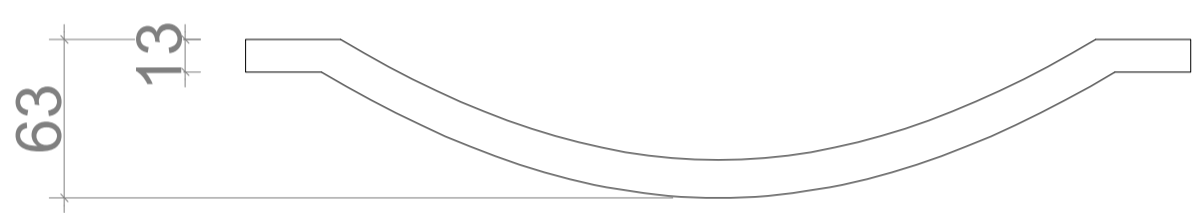

**A.RESPALDO**  
1:4

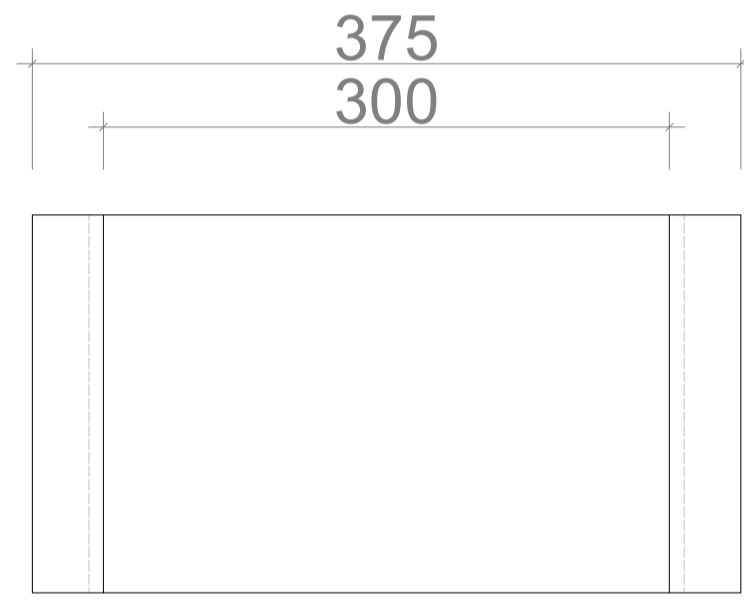

**A.RESPALDO**  
1:4

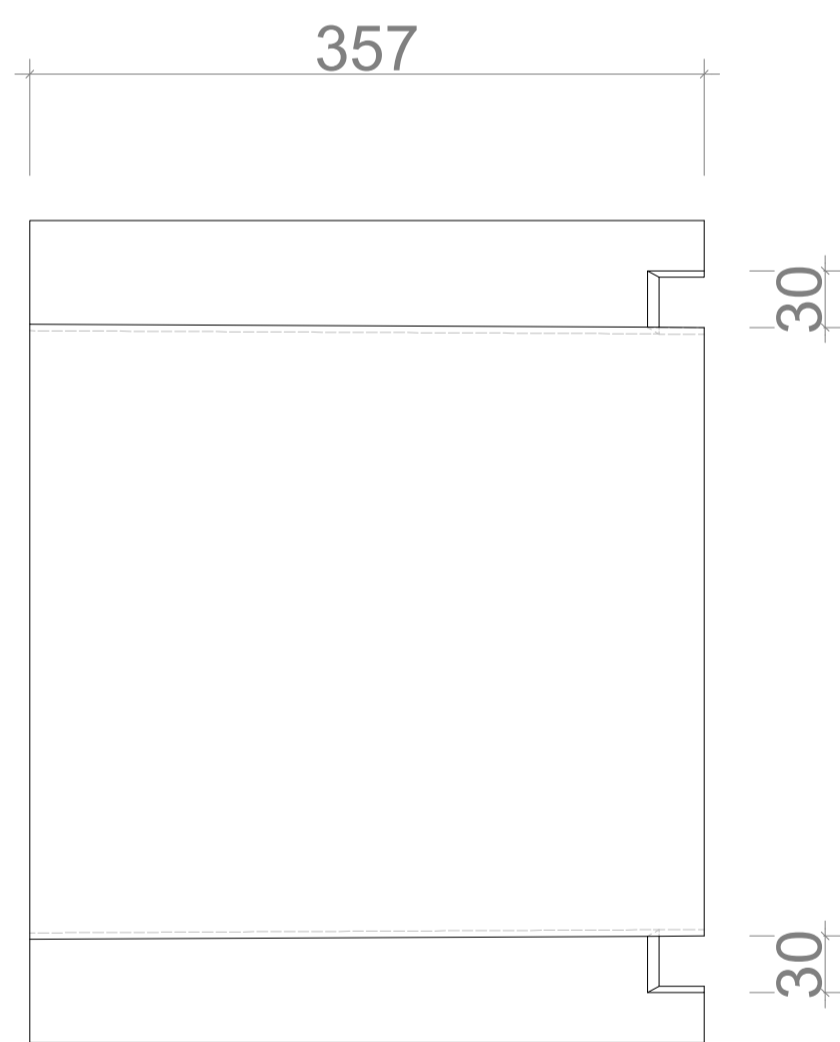

**B.ASIENTO**  
1:4

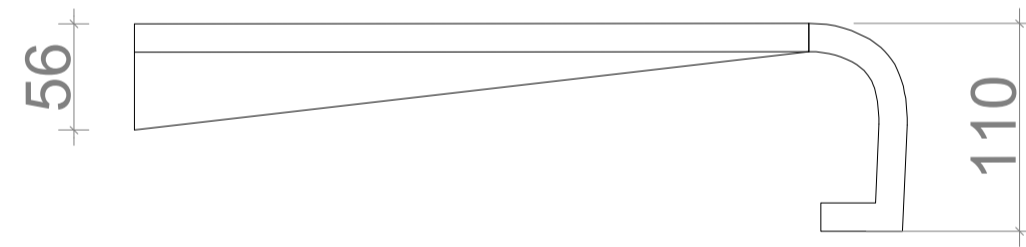

**B.PROFUNDIDAD ASIENTO**  
1:4

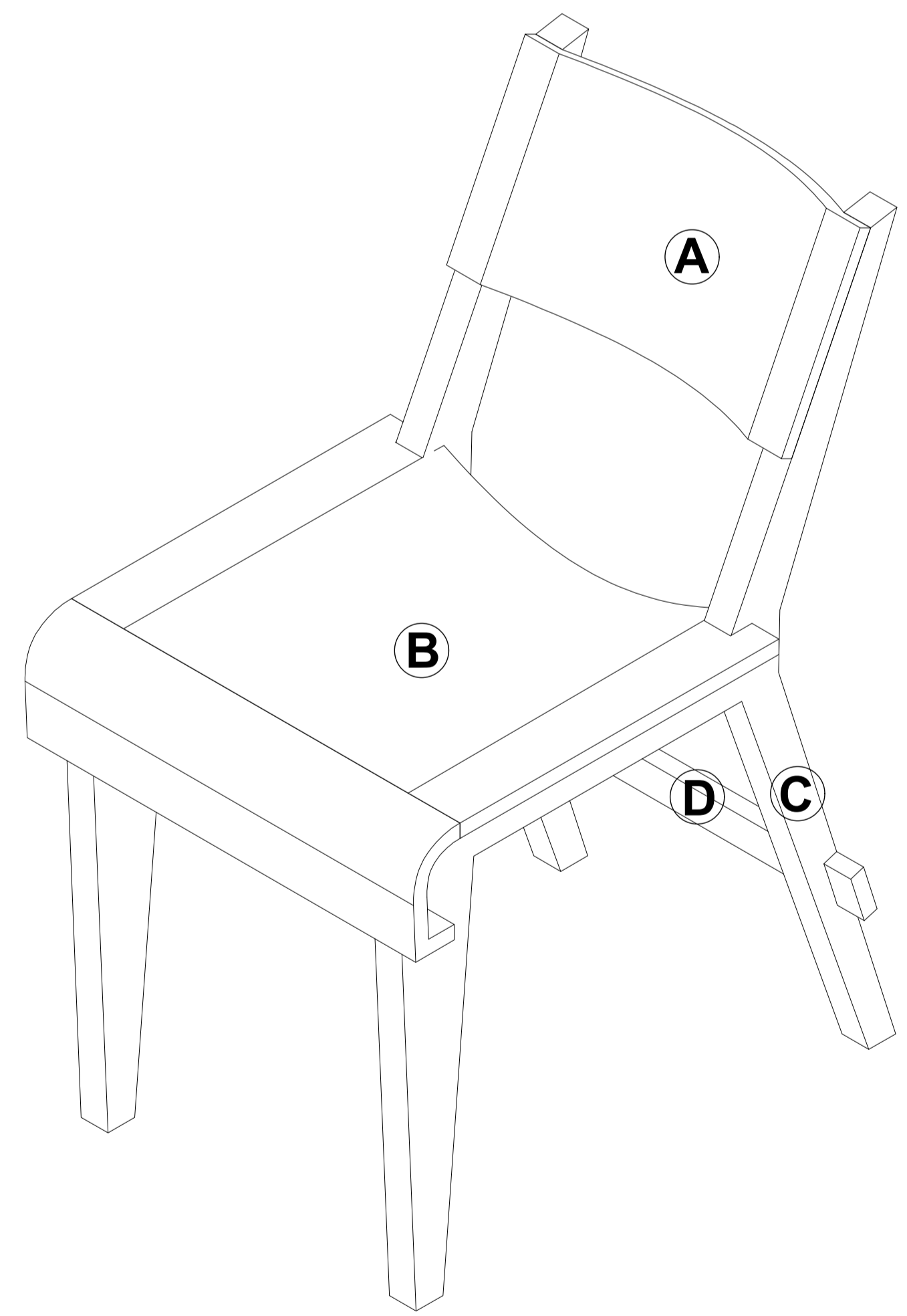

**AXONOMÉTRICA GENERAL**  
1:4

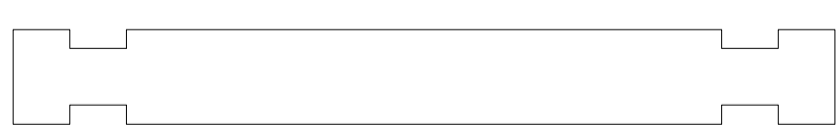

**D. PIEZA**  
1:4

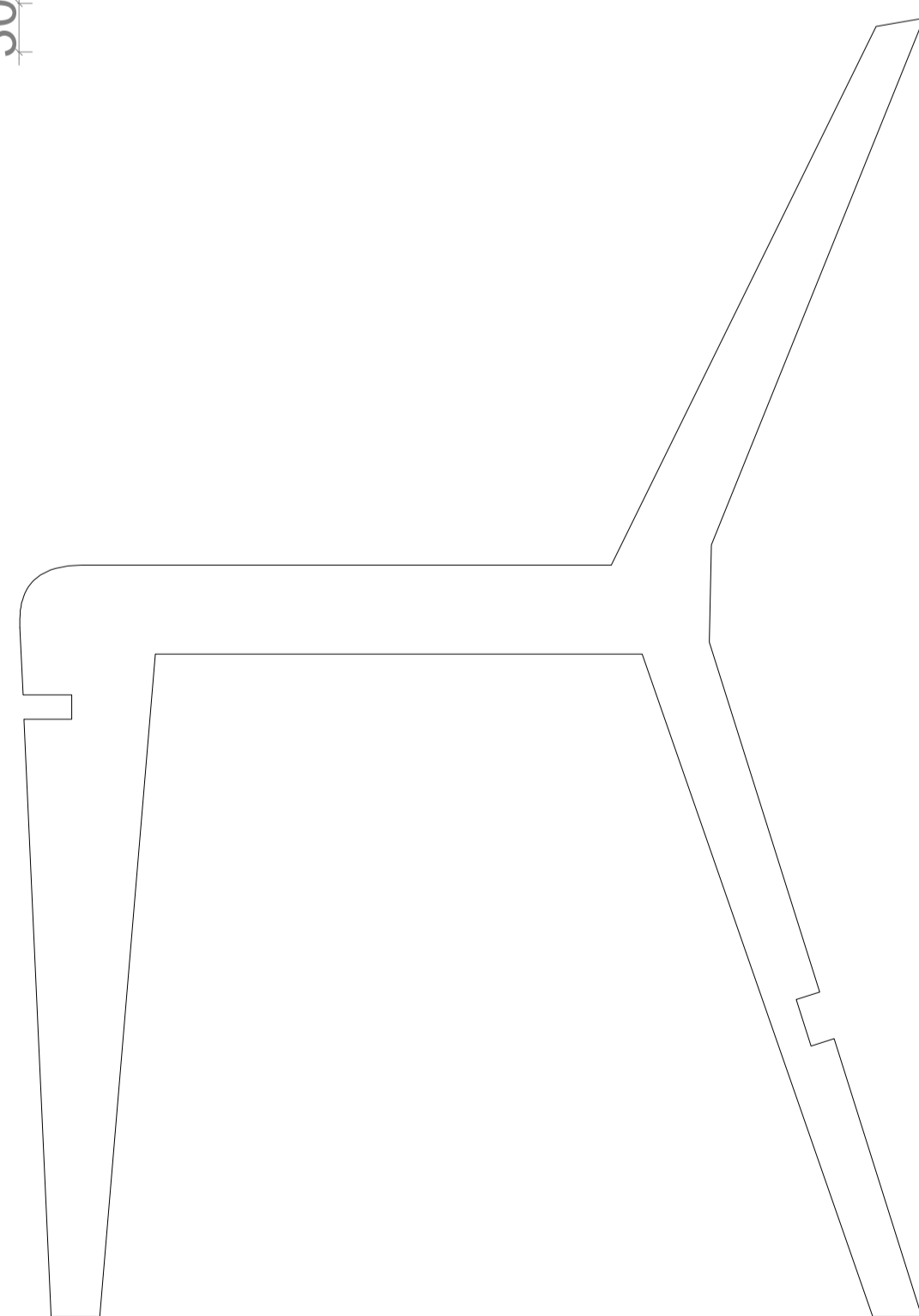

**C.PATAS LATERALES**  
1:4

**DESPIECE**

MARÍA JESÚS MATTÁ

ESCALA 1:4

Unidad de medida mm

TALLER DE FABRICACIÓN

20/04/23

Lámina 3/5